

FLUE GAS VENTING SYSTEMS



System 1738[®]
FLUE GAS VENTING



FLUE GAS VENTING SYSTEM

- UL 1738 certified for categories II and IV gas burning appliances
- Rated for flue gas temperatures up to 149°F (65°C)
- Certified system of pipe, fittings, cement, and venting accessories
- National distribution

IPEX
by aliaxis

We build tough products for tough environments[®]

The first engineered PVC Flue Gas Venting System certified to UL 1738

System 1738® is a system fully certified to UL 1738; consisting of pipe, fittings, termination kits, and cement manufactured to strict quality, performance and dimensional standards.

To aid installers and inspectors is our System 1738 Installation Guide.

The contents of the guide are part of the certification process and contain many important aspects of installation to ensure successful, code-compliant installations. Installation instructions provided by the Guide includes support spacing, expansion and contraction, solvent welding procedures and flue gas venting accessories.

NOTICE

Please reference system1738.com for complete details on information provided in this document including safety precautions, installation and warranty.



Experience the Difference

The Code Change and Better Venting Option

Historically, the plumbing and HVAC industry has not nationally regulated the use of plumbing pipes and accessories used for thermoplastic Flue Gas Venting (FGV) installations. Currently, the use of plumbing Schedule 40 Solid Wall or Foam Core Drain, Waste, and Vent (DWV) pipe and fittings are allowed if they are referenced as options in the appliance installation instructions.

Schedule 40 Solid Wall or Foam Core plumbing DWV pipe and fittings do NOT meet the UL 1738 safety standard for venting one of the most dangerous and silent killers: carbon monoxide.

The use of plastic venting systems on gas fired water heaters, furnaces and boilers has undergone a significant change. NFPA 54-18 (National Fire Protection Association) National Fuel Gas Code and IFGC-18 (International Fuel Gas Code) now recognizes the UL 1738 venting standard as an option for venting Categories II and IV gas fired appliances.

The change to both these model codes empowers relevant authorities to allow the use of a vent material specified by the appliance manufacturers to be certified to the UL 1738 venting standard.



Safe Design

The New Standard in Life Safety

The safety concern today is in the use of plumbing Solid Wall Schedule 40 or Foam Core DWV pipe and fittings in FGV applications. These products were never intended to be used in FGV applications, but they have been chosen because they are often the least expensive materials available.

Some manufacturers of these products have stated repeatedly that these products are not designed for FGV. These products do not meet the key performance requirements nor most of the material requirements of UL 1738. **Simply put, plumbing DWV products are NOT designed to meet the life safety standards of FGV applications.**

ASTM Standards vs. UL 1738

Currently, the use of plumbing thermoplastic products are referenced in the ANSI Z21 appliance standards as being suitable materials in FGV applications; provided that, they are certified to specific ASTM plumbing standards and are specified by the appliance manufacturer as an approved option for venting. However, these ASTM Standards are for fluid handling applications only. For example, ASTM D1785 is a standard for pressure rated Schedule 40, 80, and 120 PVC pipe intended for use with distribution of pressurized liquids only. In fact, the 2015 standard states:

“This standard specifies dimensional, performance and test requirements for plumbing and fluid handling applications only. It does not include provisions for the use of these products for venting of combustion gases. UL 1738 is a standard that does include specific testing and marking requirements for flue gas venting products, including PVC”
ASTM D1785-15 Standard reference.

Plumbing Product Standard vs. FGV Installation

Standards	Description	ABS Foam-core	ABS	PVC Foam-core	PVC	PVC DWV	System 1738®
ASTM D1785	Schedule 40, 80 and 120 PVC, Pressure Rated for Water				×		
ASTM D2665	PVC Drain Waste Vent (DWV) Pipe and Fittings					×	
ASTM F891	PVC Pipe with a Cellular Core for Non Pressure			×			
ASTM D2241	PVC Pressure Rated Pipe - SDR Series				×		
ASTM D2661	ABS Schedule 40 Pipe and Fittings		×				
ASTM F628	ABS DWV Schedule 40 Pipe with a Cellular Core	×					
UL 1738	Vent Systems for Gas-Burning Appliances Categories II and IV						✓

✗ Not Recommended or warranted in a FGV installation (ASTM Standards are for liquid handling applications only)

✓ Recommended and warranted in a FGV installation



Venting. ReInvented™

Advantages

System 1738 Flue Gas Venting offers a full range of pipe, fittings and termination components that are manufactured from an engineered PVC compound, rated for a maximum flue gas temperature of 149°F and that are fully certified to the rigorous requirements of UL 1738 venting standard for gas-burning appliances, Categories II and IV.

The Certified System for Flue Gas Venting

System 1738 pipes and fittings are black in color which protects against UV degradation. Material type, application and temperature rating is included in the pipe print line as well as on the orange and black labels applied to each fitting. All System 1738 products have been certified by Intertek and carry an ETL mark as proof of certification. Markings on pipe and fittings are required by UL 1738 and clearly distinguish a certified gas venting system from every day, non-certified plumbing pipe and fittings. Look for the System 1738 label and the mark of a recognized certification agency as assurance that the venting system being used is certified.

System 1738® Physical Properties and Conformity to UL 1738

To be certified to the UL 1738 standard, System 1738 underwent extensive material and performance testing. In addition, part of the certification process included formal approval of all installation instructions and special marking and labeling requirements for FGV pipe, fittings, and cement. Meeting the UL 1738 standard ensures that System 1738 is suitable and safe for FGV applications.

This chart reflects only a selection from the list of conditioning and test requirements in UL 1738.

Section	System Performance Test Requirements	UL 1738	Section	Material Conditioning & Test Requirements	UL 1738
19	Temperature Structure	✓	40.2	Elevated Temperature Conditioning	✓
22.4	Joint Load	✓	40.3	Light and Water Conditioning	✓
28	Vent Sag	✓	40.4	Condensate Conditioning	✓
29	Puncture	✓	42.2	Tensile	✓
35	Joint Tightness	✓	42.3	Impact	✓
37	Low Temperature Handling	✓	42.5	Flammability	✓
42.4	Crush Resistance and Stiffness	✓	43.1	Heat Deflection Temperature	✓

✓ System 1738® meets all requirements listed above

Size Selection

2" – 4" pipe and fittings offer a homogeneous solvent weld joining system and are manufactured to STURDY DIMENSIONS to provide a strong, rigid vent piping system.

System 1738[®] Cements and Primers

System 1738 solvent cement is specifically formulated and certified for flue gas venting applications to provide welded joints. This cement includes an optical brightener as an additive that is visible under a UV light for identification of the proper cement for the application.

Primers are also offered for applications where the gas venting system is to be installed in temperatures below 32°F (0°C).

Cutting and deburring tools are also available.

System 1738 pipe, fittings and cement are certified as a system and must be installed as such. Different manufacturers have different materials, joining systems and or cements. **Do NOT mix pipe, fittings, solvents, or joining methods from different manufacturers. Do NOT use other IPEX product not listed in this brochure. This will result in unsafe conditions and will void certification and warranty.**

We are proud to offer you our 10-year industry-leading Product Warranty on our System 1738 FGV piping system.



System 1738[®] Installation and Training

The certified System 1738 Installation Methods booklet may be obtained by contacting IPEX or may be viewed online at system1738.com.

SYSTEM 1738 TRAINING IS AVAILABLE focusing on proper solvent welding and installation. Contact IPEX for details.

IPEX recommends that installers attend formal training on System 1738 every three years to ensure proper installation methods are utilized at all times.

Termination Options

Concentric Vent Kit

Allows for both exhaust and intake pipes to penetrate the roof or side wall through only one hole.

Molded cap with socket allows for vent screens and extensions. Cap can be mechanically fastened, allowing for quick removal and easy cleaning

Pipe-in-pipe design allows for single wall penetration resulting in fewer holes to core & seal

Short branch on the Wye makes for a stronger fitting which can be installed in tighter spaces

Integral fins prevent the cap from sitting flush to the wall, ensuring proper spacing needed for air flow

Concentric Vent Kits (PVC) 2", 3" & 4" diameters

■ Fresh Air
■ Exhaust

All vent kits are supplied black in color; but can easily be painted to blend in with the exterior

Low Profile Side Wall Vent Kit

Offers a lower profile alternative to the typical two pipe side wall snorkel termination. They include integrally molded vent screens, and the design neatly disguises both the intake and exhaust.

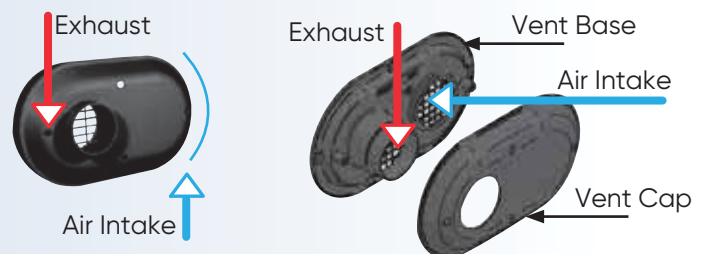

Venting. ReInvented™

The Code Change and Better Venting Option

The use of plastic venting systems on gas fired water heaters, furnaces and boilers has undergone a significant change. The NFPA 54-18 and IFGC-18 Fuel Gas Codes now recognizes the UL 1738 venting standard across the United States.

The UL 1738 Standard Ensures

- Pipe, fittings, and cement compatibility
- Products are tested and certified for the application
- Easy identification of UL 1738 certified venting system components
- Certified installation instructions including support spacing, solvent welding, and maintenance
- Single source product support

System 1738® Flue Gas Venting System Includes

- UL 1738 certified vent system for Categories II and IV gas burning appliances
- Rated for flue gas temperatures up to and including 149°F (65°C)
- Sizes include 2", 3", and 4"
- Pipe, fittings, cement, and venting accessories
- Availability of cutting and bevelling tools to ensure proper joint installation
- Terminations and accessories can be painted to match building exteriors
- Installation training and literature support
- National distribution

System 1738[®]

FLUE GAS VENTING

Meeting Standards

System 1738[®] is the first engineered PVC venting system certified to UL 1738. It offers a complete certified system of pipe, fittings and cement meeting the stringent demands of the UL 1738 venting standard.

Benefits of Using System 1738

- A** Fully certified as a complete system of pipe, fittings, cement, and venting accessories
- B** Permanent solvent welding joining system
- C** Material type, temperature rating and product certification is included in the pipe print line and fitting certification sticker
- D** Carbon monoxide warning label
- E** Solvent cement formulated for the application

! It is important to note that different manufacturers have different joint systems and adhesives. Do NOT mix pipe, fittings or joining methods from different manufacturers.

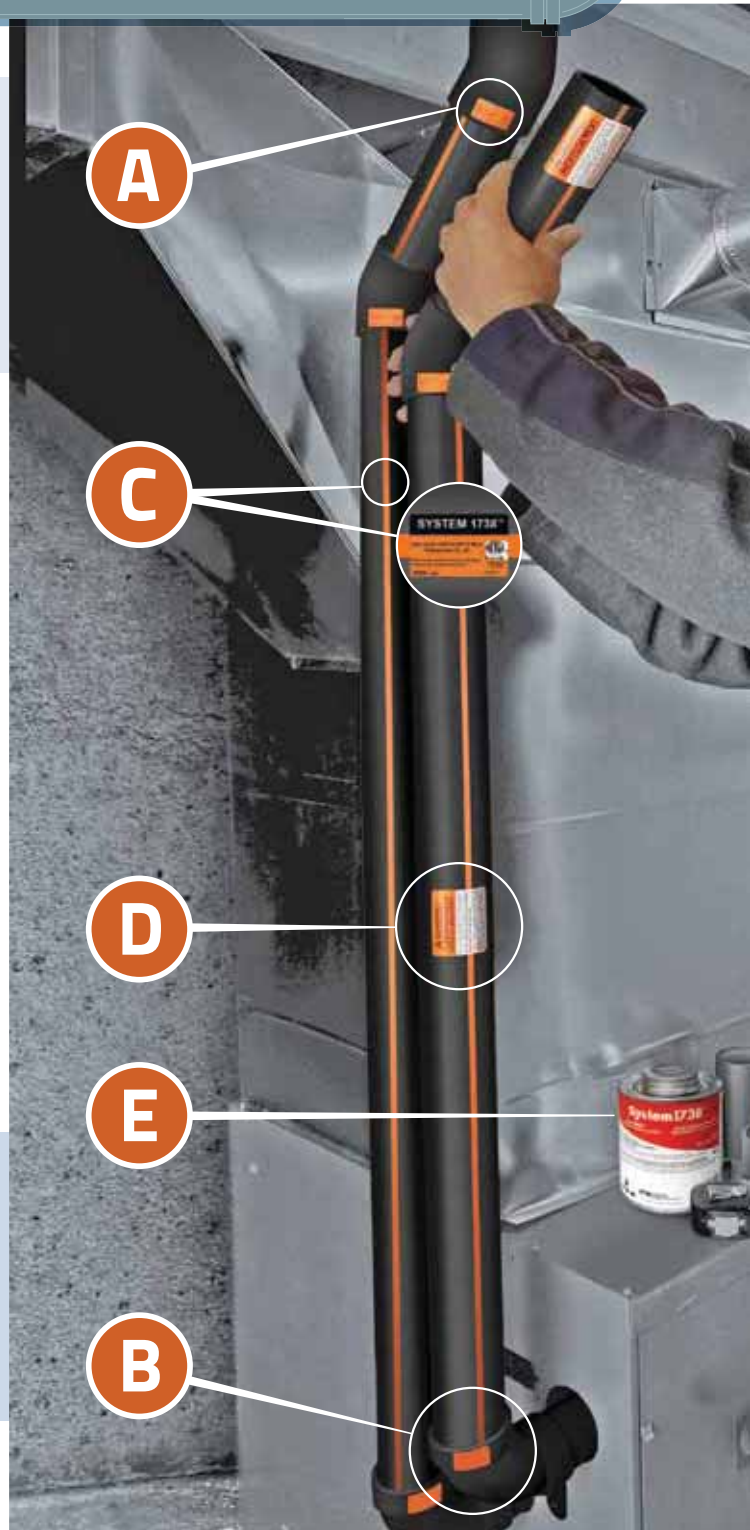



Success in Manufacturing

Innovative Piping Systems

IPEX looks to the future with innovative product development and a focus on customer needs. Our systems approach to products offers customers complete fittings, accessories, and piping systems in diameters 1/2" through 60". Customers are guaranteed high quality products, reliable compatibility, simplicity in supply, and superb sales support—all from one manufacturer.

Below are some of our innovative, customer-inspired systems:

AquaRise® Potable Water Piping System for commercial, industrial and high-rise buildings, provides designers and installers with a long-overdue, viable option to copper.

Centurion® PVC Pipe and Fittings are available in sizes from 14" - 60" diameter, extending corrosion-free benefits to the municipal market.

Novaform™ is a durable and cost-efficient PVC liner for sewer and culvert rehabilitation, bringing the lasting benefits of engineered PVC pipe to the trenchless pipe rehabilitation industry.

Blue Brute® PVC Pipe and Fittings offer superior strength with corrosion-resistant performance and the ability to flex, allowing the system to perform under high traffic loads and deep burial conditions.

Vortex™ Flow Insert for Odor and Corrosion Control is revolutionary technology for eliminating odorous emissions and minimizing corrosion in vertical sewer drops.

Today, IPEX continues to employ a dedicated team of innovation managers to continue looking for and developing new, innovative, thermoplastic products for improved piping systems.

FLUE GAS VENTING PRODUCT SELECTION

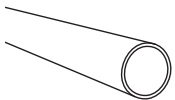
	Dimension inches	Product Code
	2	394000
	3	394001
	4	394002

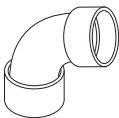
	Dimension inches	Product Code
	2	397035
	3	397025

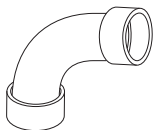
	Dimension inches	Product Code
	2 EL	397022
	3 EL	397023
	4 EL	397124

	Dimension inches	Product Code
	2	397232
	3	397233
	4	397234

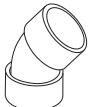
	Dimension inches	Product Code
	2	397242
	3	397243
	4	397244

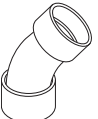
	Dimension inches	Product Code
	2 L	397010
	3 L	397011

	Dimension inches	Product Code
	2	397071
	3	397223
	4	397117

	Dimension inches	Product Code
	2	397252
	3	397253
	4	397254

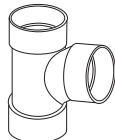
	Dimension inches	Product Code
	2	397082
	3	397083
	4	397084

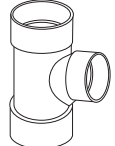
	Dimension inches	Product Code
	2 x 1-1/2	397056
	3 x 1-1/2	397061
	3 x 2	397185
	4 x 2	397184

	Dimension inches	Product Code
	2	397352
	3	397353
	4	397354

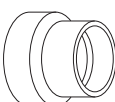
	Dimension inches	Product Code
	3 x 2	397364
	4 x 2	397365
	4 x 3	397366

Note: For use with gas fired appliances producing flue gases 149°F (65°C) or less.
Note: Do NOT mix pipe, fittings or joining methods from different manufacturers.

FLUE GAS VENTING PRODUCT SELECTION

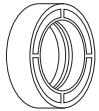
	Dimension inches	Product Code
	2 x 1-1/2	397282
	3 x 2	397284

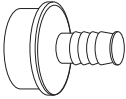
	Dimension inches	Product Code
	1-1/2 x 1/2	397278

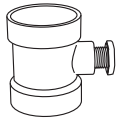
	Dimension inches	Product Code
	2	397511
	3	397512
	4	397513

Includes 1/2" plug

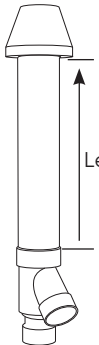
	Dimension inches	Product Code
	2 x 16	397005
	2 x 28	397105
	2 x 40	397125
	3 x 20	397006
	3 x 32	397106
	3 x 44	397116
	4 x 36	397021

Vent screen not included

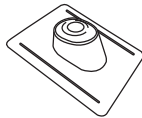
	Dimension inches	Product Code
	2	397191
	3 - 4	397206

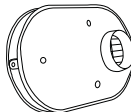
	Dimension inches	Product Code
	2	397984
	3	397985
	4	397986

	Dimension inches	Product Code
	2	397063
	3	397064
	4	397055

Not UL 1738 Certified

	Dimension inches	Product Code
	2	397216
	3	397219

Not UL 1738 Certified

	Dimension inches	Product Code
	2	196050
	3	196051
	4	196052

Vent screens are not UL 1738 Certified.
Friction fit the vent screen inside the termination fitting bell to prevent debris & rodents from entering the vent.

Note: For use with gas fired appliances producing flue gases 149°F (65°C) or less.
Note: Do NOT mix pipe, fittings or joining methods from different manufacturers.

Dimension inches	Product Code
---------------------	-----------------

DEBURRING TOOL (DEB 4)

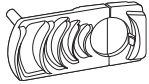

1-1/2 to 4	196246
------------	--------

To ensure quality solvent cement connections, deburr all pipe ends prior to cementing.

Dimension inches	Product Code
---------------------	-----------------

CUTTER

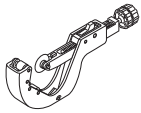

1-1/2 to 3	196247
------------	--------

Volume ml/imperial	Product Code
-----------------------	-----------------

PVC FGV CEMENT MEDIUM BODIED (LOW VOC) - AUBURN



pint (473ml)	397040
quart (946ml)	397041

PVC FGV PRIMER (LOW VOC) - YELLOW



pint (473ml)	397042
quart (946ml)	397043

- Primer shall be used when installing System 1738 PVC products at temperatures below 32°F (0°C).
- Primer is required in some municipalities regardless of temperature, verify with your local regulatory authority.

Note: Use only System 1738 cements and primers. Substituting other cements and primers will void certification and warranty.

All pint and quart cans supplied with dauber (applicator) for use up to 4".

**Note: For use with gas fired appliances producing flue gases 149°F (65°C) or less.
Note: Do NOT mix pipe, fittings or joining methods from different manufacturers.**

SALES AND CUSTOMER SERVICE

IPEX USA LLC

Toll Free: (800) 463-9572

system1738.com | ipexna.com

About the IPEX Group of Companies

As leading suppliers of thermoplastic piping systems, the IPEX Group of Companies provides our customers with some of the world's largest and most comprehensive product lines. All IPEX products are backed by more than 50 years of experience. With state-of-the-art manufacturing facilities and distribution centers across North America, we have earned a reputation for product innovation, quality, end-user focus and performance.

Markets served by IPEX group products are:

- Electrical systems
- Telecommunications and utility piping systems
- Industrial process piping systems
- Municipal pressure and gravity piping systems
- Plumbing and mechanical piping systems
- Electrofusion systems for gas and water
- Industrial, plumbing & mechanical, and electrical cements
- Irrigation systems
- PVC, CPVC, PP, PVDF, PE, and ABS pipe and fittings

System 1738® is manufactured by IPEX Inc. and/or IPEX USA LLC. and distributed in the United States by IPEX USA LLC.

System 1738® and Venting. RelInvented™ are trademarks of IPEX Branding Inc.

This literature is published in good faith and is believed to be reliable. However, it does not represent and/or warrant in any manner the information and suggestions contained in this brochure. Data presented is the result of laboratory tests and field experience.

A policy of ongoing product improvement is maintained. This may result in modifications of features and/or specifications without notice.



BRMESSIP190101UR2
© 2019 IPEX MS0028U

