



Valves

 **MATCO-NORCA**
Global sourcing. National compliance. Local service.

CALIFORNIA • TEXAS • ILLINOIS • NEW YORK

Table of Contents

ITEM NAME PAGE NUMBER

A
 Angle Control Valve9
 Angle Valve23, 30, 34
 Aztec Boiler Drain24
 Aztec Garden Valve24
 Aztec Hose Bibb25
 Aztec Low Pressure Valves24-25
 Aztec Sillcocks24

B
 Back Flow Preventers21
 Balancing Valves35
 Ball Drip Valve21
Ball Valves

Carbon Steel39, 40, 42
 Compression Ends8
 Cold Expansion7
 CPVC13
 CSA4-5
 Drop Ear7
 Full Port4-8
 Gas10
 Heavy Duty5
 Hose Bibb26
 Locking Handles4
 Long Bonnet6
 Male X Female4, 8
 Nickel Plated5-6
 One Piece7
 Pex Ends7
 Press5
 Push Connect5
 PVC12-13
 SS Cross Handles6
 SS Thumb Grip Handles4
 Stainless Steel7, 39-41
 Standard Port5-8
 Tee Handles4
 UL/FM4-5
 Uni-Flange8
 UPC4-5, 7
 With Waste Drain7-8
 Blind Flanges56

Boiler Drains
 Aztec24
 Brass22
 Bolt & Gasket Sets57
 Bolts57, 58

Butterfly Valves
 B1 - PVC Wafer Style61
 B1 - Parts61
 B5 - Wafer Style62
 B5 - Lug Style62
 B5 - Parts63
 B6 - Wafer Style64
 B6 - Lug Style64
 B6 - Parts65
 B7 - Wafer Style65
 Butterfly Valve Part Breakdown60

C
Carbon Steel Ball Valves

Carbon Steel Valves Part Breakdown38
 Flanged39
 Mounting Pad39, 40, 42
 Socket Weld42
 Threaded40, 42
 Three Piece42

ITEM NAME PAGE NUMBER

C (continued)
 Two Piece39, 40
Cast Iron Check Valves
 AWWA53
 IBBM52
 Lever & Weight53
 Resilient Seat52, 53
 UL/FM53
 Wafer54

Cast Iron Flanges
Cast Iron Gate Valves

AWWA51
 Flanged47, 49-51
 IBBM49-50
 NRS47-50
 OS&Y49-51
 Resilient Wedge47-48, 51
 Ring Tite47
 Rising Stem49-51
 Threaded47, 49-50
 UL/FM51
 Cast Iron Globe Valve50

Check Valves
 Brass18
 Bronze18-19
 Inline19-20
 BUNA-N Seat18
 Horizontal Pattern18
 NSF18-19
 PVC20
 Spring Loaded19
 Stainless Steel43
 Sump Pump20
 Swing18-19
 Y Pattern19
 Circulator Flange Kit35
 Coin Key Valves31
 Cold Expansion7
 Companion Flanges56
 Convector Valve31
 CPVC Ball Valve13

D
 Drain Valve31
 Drip Valve21

Ductile Iron Gate Valves
 AWWA46
 Flanged46, 48, 51
 Flanged X MJ46
 Mechanical Joint46
 NRS46, 48
 OS&Y51
 Resilient Wedge46, 48, 51
 Ring Tite48
 Rising Stem51
 Threaded48
 UL/FM51

E
 Escutcheons & Keys11
 Evaporator Cooler Valve34

F
 Flanges56
 Flange Accessory Kits57
 Flange Kits35
 Float Rod34
 Float Valve34
 Foot Valve19
 Frost Free Sillcock29

ITEM NAME PAGE NUMBER

G
 Gaskets57
Gas Valves
 1 Piece - CSA/UL10
 2 Piece - CSA/UL10
 Log Lighter - CSA11

Gate Valves
 Compression Ends16
 Cross Handle14-15
 Crown Handle14
 Curb Stop Handle15
 Federal Specification15
 Heavy Pattern14-15
 IAPMO14
 NRS14-16
 NSF14
 OS&Y15
 Quick Opening16
 Radiator30
 Rising Stem15
 Stainless Steel43
 Wheel Handle14-16
 With CPVC Stub Outs16
 With Drain14
 UL/FM15

Globe Valves
 Cast Iron50
 Hard Seat9
 Long Bonnet9
 Soft Seat9
 Stainless Steel43
 Stop & Waste23
 Stops23

Garden Valve
 Aztec24
 Brass28

H
 Hose Bibb25-27

I
 Inline Check Valve19-20

L
 Log Lighters - CSA11
 Loose Key Valve25

M
 Meter Valve34
 MJ Accessory Sets58

N
No Kink
 Valve25
 Hose Bibb25-26

O
 Oil Barrel Faucet35
 Oil Tank Valve35
 Operating Nuts59

P
 Press Ball Valve5
 Purge Valve35
 Push Connect Ball Valve5
 PVC Flanges56

PVC Valves
 Ball Valves12-13
 Check Valves20

Q
 Quick Opening Gate Valve16

ITEM NAME PAGE NUMBER

R
Radiator Valves
 Angle Valve30-31
 Hot Water Radiator31
 Radiator Gate Valve30
 Steam Radiator30-31

S
 Silent Check Valve54
Sillcocks
 Aztec24
 Brass28
 Frost Free29
 With Pex Ends29
 With Vacuum Breaker28
 Slip Nuts30
 Spring Loaded Check Valve19

Stainless Steel Ball Valves
 Flanged39
 Mounting Pad39-41
 One Piece5, 39
 Socket Weld41
 Stainless Steel Valves Part Breakdown38
 Threaded39-41
 Three Piece41
 Two Piece39, 40
 Stainless Steel Check Valve43
 Stainless Steel Gate Valve43
 Stainless Steel Globe Valve43
 Stainless Steel Y Strainer43
 Steam Valves30-31

Stop Valves
 Brass23
 Globe23
 Sump Pump Check Valve19-20

Supply Valves
Multi Turn
 Angle32
 Compression32
 Dual Compression32
 Pex Compression32
 Straight32

Quarter Turn- Oval Handles
 Angle33
 Compression33
 Dual Compression33
 Pex Compression33
 Straight33
 Swing Check Valve18-19

T
 T-Wrench58

V
Vacuum Breakers
 Aztec24-25
 Brass21
 Chrome21

W
 Wafer Check Valve54
 Water Heater Drain Valve31
 Wheel Handles59

Y
Y Strainers
 Bronze17
 Cast Iron55
 Stainless Steel43

Certifications & Approvals

Committed to Quality

Matco-Norca is committed to maintaining a high standard of quality for all the products we offer. Most products in this catalog are labeled with a designated approval or certification code. Below is a brief description of these approvals.



ADA **American Disabilities Act** — Protecting the rights of people with physical or mental disabilities.



ANSI **American National Standards Institute** — Organization that coordinates work among U.S. Standards writing groups; Works in conjunction with other groups such as ISO, ASME, ASTM, etc.



ASME **American Society of Mechanical Engineers** — Develops standards and testing criteria for finished products.



ASSE **American Society of Sanitary Engineering** — Develops standards and qualifies products for plumbing and sanitary installations.



ASTM **American Society for Testing Materials** — Develops standards for materials, products, systems and services.



AWWA **American Water Works Association** — Promotes public health through improvement of water quality. Develops standards for valves, fittings and equipment.



CSA **Canadian Standards Association** — Develops standards, tests and qualifies products used in gas lines and gas appliance installations.



FM **Factory Mutual** — Develops standards and qualifies products for use by the general public.



ISO **International Standards Association** — A worldwide process control organization. An internationally recognized certification for manufacturers that comply with high standards of quality control. Developed standards ISO-9000 through ISO-9004



MSS **Mechanics Standardization Society of the Valves & Fittings Industry, Inc.** — A committee of manufacturers that develops technical codes and standards for the valve & fitting industry.



SDWA **The Safe Drinking Water Act** — Is the main federal law that ensures the quality of Americans' drinking water. Under SDWA, EPA sets standards for drinking water quality and oversees the states, localities, and water suppliers who implement those standards. Weighted average lead content of water contact components must be 0.25% or less.



NSF **NSF International** — An organization committed to public health that writes standards and certifies products for food, water and consumer products.



UL **Underwriter's Laboratory** — Tests and qualifies valve and fittings products under UL standards for safety.



UPC **Uniform Plumbing Code** — Developed by the International Association of Plumbing and Mechanical Officials to govern the installation and inspection of plumbing systems as a means of promoting the public's health, safety and welfare.



USC **University of Southern California** — Foundation for Cross-Connection Control and Hydraulic Research that lists approved backflow prevention assemblies.

Ball Valves - Full Port



757

Ball Valve - Full Port - Forged Brass - UL/FM Certified

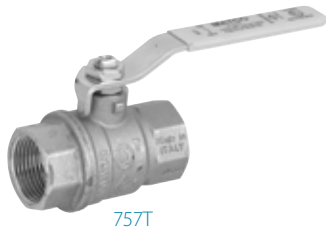

757T

Lead Free Version Available

CSA Approved

150 SWP 600 WOG

IPS

MATCO-NORCA MODEL NUMBER	SIZE	CARTON QUANTITIES INNER	MASTER
757T01	1/4"	12	144
757T02	3/8"	12	144
757T03	1/2"	12	144
757T04	3/4"	10	70
757T05	1"	10	60
757T06	1-1/4"	6	36
757T07	1-1/2"	4	24
757T08	2"	4	6



759

Ball Valve - Full Port - Forged Brass

Lead Free Version Available

CSA Approved - 1/2" - 2" IPS Only

1/4" - 2" - 150 SWP 600 WOG 2-1/2" - 4" - 100 SWP 600 WOG

IPS

C x C



759T

759C

MATCO-NORCA MODEL NUMBER	SIZE	CARTON QUANTITIES INNER	MASTER
759T01	1/4"	15	120
759T02	3/8"	15	120
759T03	1/2"	15	120
759T04	3/4"	10	60
759T05	1"	8	48
759T06	1-1/4"	4	24
759T07	1-1/2"	2	24
759T08	2"	2	12
759T09	2-1/2"	2	6
759T10	3"	1	4
759T11	4"	1	2

Also Available with Tee Handle: 1/4" - 1"

759T01T	1/4"	12	144
759T03T	1/2"	15	120
759T04T	3/4"	10	60
-	1"	8	48

Also Available with Stainless Steel Thumb Grip Handle: 1/2" - 1-1/4"

Handles Are Not Interchangeable.

759T03TS	1/2"	15	120
759T04TS	3/4"	10	80
759T05TS	1"	8	48



LOCKING HANDLE AVAILABLE FOR LEVER OPERATED 759 BALL VALVE



759TS



759MF0001T

759MF

Ball Valve - Full Port - Forged Brass - MIP X FIP

600 WOG

Lead Free Version Available

With Tee Handle

759MF0001T	1/8" X 1/4"	12	144
759MF00T	1/8" X 1/8"	12	144
759MF01T	1/4" X 1/4"	12	144

Ball Valves - Full Port & Standard Port

Ball Valves

MATCO-NORCA MODEL NUMBER **SIZE** **CARTON QUANTITIES INNER MASTER**



759PLF

Lead Free Press Ball Valve - Full Port - Forged Brass



759P

1/2" - 2" - 600 WOG

759P03LF
759P04LF
759P05LF
759P06LF
759P07LF
759P08LF
759P09LF
759P10LF
759P11LF

2-1/2" - 4" - 250 WOG

1/2"	15	120
3/4"	10	60
1"	8	48
1-1/4"	4	24
1-1/2"	2	24
2"	2	12
2-1/2"	2	6
3"	2	4
4"	1	2



720QLF

Lead Free Push Connect Ball Valve - Full Port - Forged Brass



720QLF

200 WOG

720Q03LF
720Q04LF
720Q05LF

1/2"	12	72
3/4"	12	60
1"	6	36

750LF

Lead Free Ball Valve - Full Port - Forged Brass



750T05LF

750C05LF

600 WOG

IPS

750T03LF
750T04LF
750T05LF
750T06LF
750T07LF
750T08LF

C x C

750C03LF
750C04LF
750C05LF
-
-
-

1/2"	8	80
3/4"	8	64
1"	8	48
1-1/4"	4	24
1-1/2"	4	24
2"	2	12



755

Ball Valve - Full Port - Forged Brass - Heavy Duty - Made In Italy



755T

1/4" - 2" - 150 SWP 600 WOG Nickel Plated

IPS

755T01
755T02
755T03
755T04
755T05
755T06
755T07
755T08
755T09
755T10
755T11

2-1/2" - 4" - 100 SWP 400 WOG UL/FM Certified 1/2" - 2"

1/4"	10	150
3/8"	10	120
1/2"	20	120
3/4"	12	60
1"	10	30
1-1/4"	4	20
1-1/2"	4	16
2"	2	6
2-1/2"	1	5
3"	1	5
4"	1	4

Ball Valves - Full Port & Standard Port



754N

Ball Valve - Full Port - Forged Brass

1/4" - 2" - 150 SWP 600 WOG 2-1/2" - 4" - 100 SWP 400 WOG
Nickel Plated

IPS

MATCO-NORCA MODEL NUMBER	SIZE	CARTON QUANTITIES INNER	MASTER
754T01N	1/4"	30	120
754T02N	3/8"	30	120
754T03N	1/2"	15	120
754T04N	3/4"	10	90
754T05N	1"	6	60
754T06N	1-1/4"	6	36
754T07N	1-1/2"	4	24
754T08N	2"	2	16
754T09N	2-1/2"	1	8
754T10N	3"	1	6
754T11N	4"	1	4
Also Available with Stainless Steel Cross Handle - IPS Only			
754T05NX	1"	5	60

752N

Ball Valve - Standard Port - Forged Brass

Lead Free Version Available

150 SWP 400 WOG

IPS

C x C



MATCO-NORCA MODEL NUMBER	SIZE	CARTON QUANTITIES INNER	MASTER
752T01N	1/4"	6	240
752T02N	3/8"	6	240
752T03N	1/2"	6	120
752T04N	3/4"	6	120
752T05N	1"	6	60
752T06N	1-1/4"	2	30
752T07N	1-1/2"	2	30
752T08N	2"	2	24
752T09N	2-1/2"	1	12
752T10N	3"	1	8
752T11N	4"	1	6
Also Available with Stainless Steel Cross Handle - IPS Only			
752T03NX	1/2"	10	100
752T04NX	3/4"	10	100

300BV

Long Bonnet Brass Ball Valve - Full Port



Lead Free Version Available

600 WOG



MATCO-NORCA MODEL NUMBER	SIZE	CARTON QUANTITIES INNER	MASTER
300LC3BV	1/2" C x C	6	72
300LT3BV	1/2" IPS	6	72
300LC4BV	3/4" C x C	6	72
300LT4BV	3/4" IPS	6	72

Ball Valves - Full Port & Standard Port

	MATCO-NORCA MODEL NUMBER	SIZE	CARTON QUANTITIES	
			INNER	MASTER
754PXLF Lead Free Ball Valve - Full Port - Forged Brass - Pex Barb Ends				
400 WOG				
Max 50 PSI @ 200° F				
 <p>754PX03LF</p>	754PX03LF	1/2" x 1/2" PEX	10	100
	754PX04LF	3/4" x 3/4" PEX	10	100
	754PX05LF	1" x 1" PEX	8	48
With Waste Drain & Drop Ear				
 <p>754PXDE04LF</p>	754PXDE03LF	1/2" x 1/2" PEX	8	80
	754PXDE04LF	3/4" x 3/4" PEX	8	80
	754PXDE05LF	1" x 1" PEX	4	40

	NSF UPC	MATCO-NORCA MODEL NUMBER	SIZE	CARTON QUANTITIES	
				INNER	MASTER
754PXCFLF Lead Free Cold Expansion Ball Valve - Full Port - Forged Brass - Pex Barb Ends					
400 WOG					
 <p>754PXC03LF</p>		754PXC03LF	1/2" x 1/2" PEX	10	100
		754PXC04LF	3/4" x 3/4" PEX	10	100
		754PXC05LF	1" x 1" PEX	6	48
With Waste Drain & Drop Ear					
 <p>754PXCDE04LF</p>		754PXCDE03LF	1/2" x 1/2" PEX	10	100
		754PXCDE04LF	3/4" x 3/4" PEX	10	100
		754PXCDE05LF	1" x 1" PEX	6	48

	760	Ball Valve - Standard Port - One Piece - 316 Stainless Steel		
		1/4" - 1-1/4" - 1000 WOG IPS	1-1/2" - 2" - 800 WOG	
 <p>760T</p>	760T01	1/4"	60	250
	760T02	3/8"	40	160
	760T03	1/2"	20	80
	760T04	3/4"	10	40
	760T05	1"	10	40
	760T06	1-1/4"	5	20
	760T07	1-1/2"	4	16
	760T08	2"	2	8

Ball Valves - Full Port & Standard Port



752CMPLF

752CMPLF

Lead Free Ball Valve - Standard Port - Forged Brass

400 WOG

With Compression Ends For Copper Tube Pipe

MATCO-NORCA MODEL NUMBER	SIZE	CARTON QUANTITIES INNER	MASTER
752CMP3LF	1/2" nominal	25	100
752CMP4LF	3/4" nominal	15	60
752CMP5LF	1" nominal	10	40

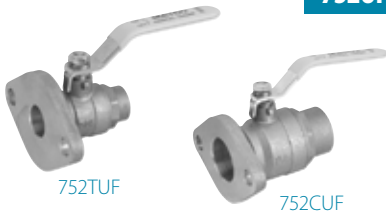

752TUF

752CUF

752UF

Ball Valve - Full Port - Uni-Flange With Gasket, 2 Bolts & 2 Nuts

IPS x Flange

Copper x Flange

MATCO-NORCA MODEL NUMBER	SIZE	CARTON QUANTITIES INNER	MASTER
752T04UF	3/4"	1	24
752T05UF	1"	2	18
752T06UF	1-1/4"	1	12
752T07UF	1-1/2"	1	10

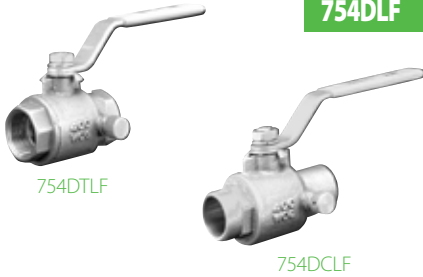

754DTLF

754DCLF

754DLF

Lead Free Ball Valve - Full Port - Cast Brass

400 WOG

With Waste Drain

IPS

C x C

MATCO-NORCA MODEL NUMBER	SIZE	CARTON QUANTITIES INNER	MASTER
754DT3LF	1/2"	20	80
754DT4LF	3/4"	10	40
754DT5LF	1"	4	16
754PCAP	1/2" - 1"	1	500

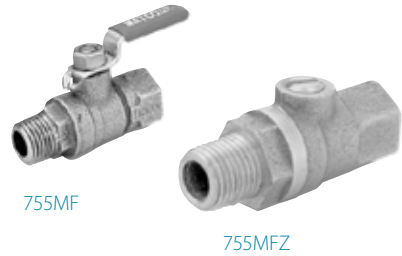

755MF

755MFZ

755MF

Ball Valve - Male X Female - Cast Bronze

Lead Free Version Available

150 SWP 600 WOG Test Cock

With Lever Handle

MATCO-NORCA MODEL NUMBER	SIZE	CARTON QUANTITIES INNER	MASTER
755MF00	1/8" MIP x 1/8" FIP	12	144
755MF0	1/8" MIP x 1/4" FIP	12	144
755MF1	1/4" MIP x 1/4" FIP	12	144

With Slotted Screw

MATCO-NORCA MODEL NUMBER	SIZE	CARTON QUANTITIES INNER	MASTER
755MFZ0	1/8" MIP x 1/4" FIP	50	200
755MFZ1	1/4" MIP x 1/4" FIP	20	200

758

Ball Valve - Full Port - Forged Brass - Made In Italy

150 SWP 600 WOG



758C

MATCO-NORCA MODEL NUMBER	SIZE	CARTON QUANTITIES INNER	MASTER
758C03	1/2"	10	120
758C05	1"	4	48
758C06	1-1/4"	4	32
758C07	1-1/2"	2	24
758C08	2"	2	16

Globe Valves

Brass Globe Valves



200TLF

200LF	MATCO-NORCA MODEL NUMBER	SIZE	CARTON QUANTITIES	
			INNER	MASTER
Lead Free Globe Valve - Brass - Hard Seat				
125 SWP 200 WOG				
IPS				
	200T02LF	3/8"	10	100
	200T03LF	1/2"	10	100
	200T04LF	3/4"	5	60
	200T05LF	1"	5	40
	200T06LF	1-1/4"	5	30
	200T07LF	1-1/2"	4	24
	200T08LF	2"	2	16



240T

240T	Angle Control Valve - Globe Pattern - Brass - Soft Seat - Cross Handle			
Lead Free Version Available				
200 PSI CWP				
IPS				
	240T04	3/4"	8	40
	240T05	1"	4	24
	240T06	1-1/4"	2	10
	240T07	1-1/2"	2	10
	240T08	2"	2	10



240TH

240H	Angle Control Valve - Globe Pattern - Brass - Soft Seat - Bronze Wheel Handle			
Lead Free Version Available				
200 PSI CWP				
IPS				
	240T08H	2"	2	24















200LT



200ALC



200L/200AL	Globe Valve - Long Bonnet - Brass - Soft Seat			
Lead Free Version Available				
125 PSI				
Straight Pattern				
	200LT3	1/2" IPS	12	72
	200LT4	3/4" IPS	12	72
	200LC3	1/2" C x C	12	72
	200LC4	3/4" C x C	12	72
Angle Pattern				
	200ALT3	1/2" IPS	12	72
	200ALC3	1/2" C x C	12	72

Gas Valves

		MATCO-NORCA MODEL NUMBER	SIZE	CARTON QUANTITIES INNER MASTER	
 <p>58LGA</p>		58LGA Gas Ball Valve - 1/2 PSIG And 5G - Two Piece			
		FIP x FIP			
		58LGA3N	1/2"	12	120
		58LGA4N	3/4"	12	120
		58LGA5N	1"	10	60
 <p>58LGA</p>		58LGA Gas Ball Valve - 1/2 PSIG And 5G - Two Piece			
		FIP x Flare			
		58LGA32	1/2" FIP x 3/8" FL	12	144
		58LGA33	1/2" FIP x 1/2" FL	12	144
		58LGA39	1/2" FIP x 9/16" - 24	12	144
58LGA4	3/4" FIP x 15/16" - 24	12	144		
 <p>58LGF</p>		58LGF Gas Ball Valve - 1/2 PSIG And 5G - Two Piece			
		Flare x Flare			
		58LGF2	3/8" O.D. x 3/8" O.D.	12	144
58LGF3	1/2" O.D. x 1/2" O.D.	12	144		
 <p>59LGA</p>		59LGA Gas Ball Valve - 1/2 PSIG And 5G - Made In Italy - One Piece			
		FIP x FIP			
		59LGA2	3/8"	1	100
		59LGA3	1/2"	12	96
59LGA4	3/4"	20	80		
 <p>59LGA</p>		59LGA Gas Ball Valve - 1/2 PSIG And 5G - Made In Italy - One Piece			
		FIP x Flare			
		59LGA32	1/2" FIP x 3/8" FL	1	144
		59LGA33	1/2" FIP x 1/2" FL	12	144
		59LGA34	3/4" FIP x 1/2" FL	1	1
59LGA39	1/2" FIP x 9/16" - 24	12	144		
 <p>59LGF</p>		59LGF Gas Ball Valve - 1/2 PSIG And 5G - Made In Italy - One Piece			
		Flare x Flare			
		59LGF2	3/8" O.D. x 3/8" O.D.	1	100
		59LGF3	1/2" O.D. x 1/2" O.D.	12	144
		59LGF4	5/8" O.D. x 5/8" O.D.	1	100

Log Lighter Valves & Accessories

SP	58ST	MATCO-NORCA MODEL NUMBER	SIZE	CARTON QUANTITIES	
				INNER	MASTER
Log Lighter Valves					
Valve Only					
	58-S03	58-S03	1/2" Straight Valve	15	120
	58-A03	58-A03	1/2" Angle Valve	15	120
Straight Valve - Complete Kits Include Valve, Escutcheon And 3" Key					
	58-STR03	58-STR03	1/2" With Chrome Plated Escutcheon & Key	1	25
	58-STR03P	58-STR03P	1/2" With Polished Brass Escutcheon & Key	1	25
Angle Valve - Complete Kits Include Valve, Escutcheon And 3" Key					
	58-ANG03	58-ANG03	1/2" With Chrome Plated Escutcheon & Key	1	25
	58-ANG03P	58-ANG03P	1/2" With Polished Brass Escutcheon & Key	1	25

SP	58	MATCO-NORCA MODEL NUMBER	SIZE	CARTON QUANTITIES	
				INNER	MASTER
Log Lighter Valve - Escutcheons & Keys					
Escutcheons					
	58-300CP	58-300CPD	Domed Chrome Plated	1	72
		58-300PBD	Domed Polished Brass	1	72
		58-300BND	Domed Brushed Nickel	1	72
		58-300SND	Domed Satin Nickel	1	72
		58-300BN	Flat Brushed Nickel	1	120
		58-300CP	Flat Chrome Plated	1	120
		58-300PB	Flat Polished Brass	1	120
Keys					
		58-200CP	3" Chrome Plated for 1/4" Stem	1	400
		58-208CP	8" Chrome Plated for 1/4" Stem	1	400
		58-208PB	8" Polished Brass for 1/4" Stem	1	180
		58-212PB	12" Polished Brass for 1/4" Stem	20	120
		58-208BN	8" Brushed Nickel for 1/4" Stem	1	400
		58-212BN	12" Brushed Nickel for 1/4" Stem	20	100
	58-212BN	58-200SN	3" Satin Nickel for 1/4" Stem	1	1

Log Lighter Valves

White PVC Ball Valves & Gray PVC Ball Valves



770

Sch. 40 PVC Ball Valve - NSF - Solvent & Threaded - PTFE Seats

150 PSI @ 73° F

Fits Both Schedule 40 & 80 Pipe

SOLVENT	THREADED	SIZE	CARTON QUANTITIES INNER	MASTER
770S03	770T03	1/2"	1	100
770S04	770T04	3/4"	1	100
770S05	770T05	1"	1	50
770S06	770T06	1-1/4"	1	50
770S07	770T07	1-1/2"	1	50
770S08	770T08	2"	1	20
770S09	770T09	2-1/2"	1	12
770S10	770T10	3"	1	12
770S11	770T11	4"	1	6

See 770N Below for 6" PVC Ball Valve.



770S



770T

770N

Sch. 40 PVC Ball Valve - Solvent & Threaded - PTFE Seats

150 PSI @ 73° F

Fits Both Schedule 40 & 80 Pipe - Economy Pattern

SOLVENT	THREADED	SIZE	CARTON QUANTITIES INNER	MASTER
770S03N	770T03N	1/2"	10	100
770S04N	770T04N	3/4"	10	100
770S05N	770T05N	1"	10	50
770S06N	770T06N	1-1/4"	5	50
770S07N	770T07N	1-1/2"	5	50
770S08N	770T08N	2"	5	20
770S09N	770T09N	2-1/2"	1	12
770S10N	770T10N	3"	1	12
770S11N	770T11N	4"	1	6
770S13N	-	6"	1	5

Sizes 2-1/2" - 6" Come with Lever Handles.



770SN



770TN



770G

Sch. 80 PVC Ball Valve - NSF - Solvent & Threaded - PTFE Seats

150 PSI

Fits Both Schedule 40 & 80 Pipe

SOLVENT	THREADED	SIZE	CARTON QUANTITIES INNER	MASTER
770S03G	770T03G	1/2"	1	100
770S04G	770T04G	3/4"	1	100
770S05G	770T05G	1"	1	50
770S06G	770T06G	1-1/4"	1	50
770S07G	770T07G	1-1/2"	1	50
770S08G	770T08G	2"	1	20
770S09G	770T09G	2-1/2"	1	12
770S10G	770T10G	3"	1	12
770S11G	770T11G	4"	1	6



770SG



770TG

PVC & CPVC Ball Valves



773S

773

PVC Ball Valve - Single Union - Solvent & Threaded - EPDM Seats

150 PSI

SOLVENT

773S07

773S08

THREADED

773T07

773T08

SIZE

1-1/2"

2"

CARTON QUANTITIES
INNER **MASTER**

1

1

48

24



772ST

772ST

Sch. 80 PVC Ball Valve - True Union - Solvent & Threaded Ends - PTFE Seats

Both Solvent & Threaded Ends In Box

772ST03

772ST04

772ST05

772ST06

772ST07

772ST08

1/2"

3/4"

1"

1-1/4"

1-1/2"

2"

1

1

1

1

1

1

72

60

45

24

16

12

See Below for 3"- 4" True Union Ball Valves.

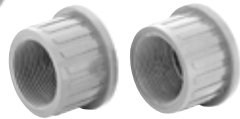

IPS & SLIP ENDS



772S

772

PVC Ball Valve - True Union - Solvent Or Threaded Ends - PTFE Seats

Solvent or Threaded Ends In Box

150 PSI

SOLVENT

772S10

772S11

THREADED

772T10

772T11

3"

4"

1

1

6

1



772T



771

CPVC Ball Valve - NSF Approved - PTFE Seats

100 PSI @ 180° F

SOLVENT

771S03

771S04

771S05

771S06

771S07

771S08

1/2"

3/4"

1"

1-1/4"

1-1/2"

2"

1

1

5

1

1

1

100

100

40

100

48

24



771S

Gate Valves

Brass & Bronze Gate Valves



514

MATCO-NORCA MODEL NUMBER SIZE CARTON QUANTITIES INNER MASTER

Gate Valve - Full Port - Cast Brass - Solid Wedge

125 SWP 200 WOG

Lead Free Version Available

Only Available in Standard

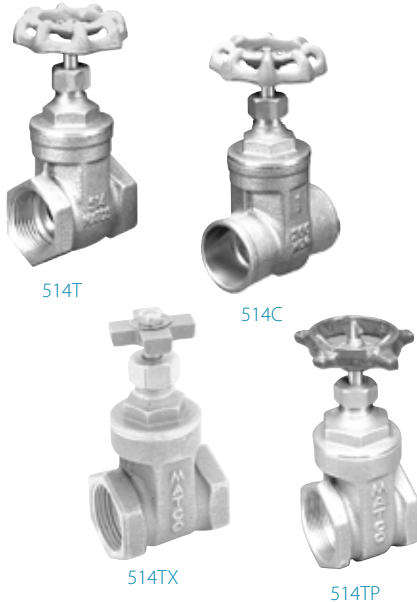

Wheel Handle IPS	Wheel Handle C x C	Cross Handle IPS	Crown Handle IPS	SIZE	INNER	MASTER
514T01	-	-	-	1/4"	10	120
514T02	-	-	-	3/8"	10	120
514T03	514C03	514T03X	514T03P	1/2"	10	120
514T04	514C04	514T04X	514T04P	3/4"	10	80
514T05	514C05	514T05X	514T05P	1"	5	60
514T06	514C06	514T06X	514T06P	1-1/4"	5	40
514T07	514C07	514T07X	514T07P	1-1/2"	5	30
514T08	514C08	514T08X	514T08P	2"	2	24
514T09	514C09	514T09X	514T09P	2-1/2"	1	10
514T10	514C10	514T10X	514T10P	3"	1	6
514T11	514C11	514T11X	514T11P	4"	1	4

Replacement Handles Of Each Type Are Available.

503

Gate Valve - Full Port - Bronze - Heavy Pattern

Lead Free Version Available

150 SWP 300 WOG

MSS-SP-80

IPS Only



503T

503T03	1/2"	10	100
503T04	3/4"	6	60
503T05	1"	5	40
503T06	1-1/4"	5	30
503T07	1-1/2"	4	24
503T08	2"	4	16
503T09	2-1/2"	2	8
503T10	3"	1	6
503T11	4"	1	4



517

Gate Valve With Drain - Cast Brass - Non Rising Stem

125 SWP 200 WOG

IPS C x C



517T

517C

517T03	517C03	1/2"	10	120
-	517C04	3/4"	10	90
517T05	517C05	1"	5	60

Bronze Gate Valves With Federal Specifications



501T

501 Gate Valve - OS&Y - Rising Stem - Bronze B62

MATCO-NORCA MODEL NUMBER	SIZE	CARTON QUANTITIES	
		INNER	MASTER
175 CWP			
IPS Only			
501T04	3/4"	6	60
501T05	1"	16	48
501T06	1-1/4"	12	36
501T07	1-1/2"	2	8
501T08	2"	1	6



511T

511C

511 Gate Valve - Federal Specification 54 Class A Type 1- Non Rising Stem - Bronze B62

150 SWP 300 WOG			
MSS-SP-80			
IPS	C x C		
511T03	511C03	1/2"	10
511T04	511C04	3/4"	10
511T05	511C05	1"	5
511T06	511C06	1-1/4"	5
511T07	511C07	1-1/2"	4
511T08	511C08	2"	2

512 Gate Valve - Federal Specification 54 Class A Type 1- Rising Stem - Bronze B62



512T

512C

150 SWP 300 WOG			
MSS-SP-80			
Lead Free Version Available	Only Available in Standard		
IPS	C x C		
512T03	512C03	1/2"	1
512T04	512C04	3/4"	1
512T05	512C05	1"	1
512T06	512C06	1-1/4"	1
512T07	512C07	1-1/2"	1
512T08	512C08	2"	1
512T09	-	2-1/2"	1
512T10	-	3"	1



513T

513TX

513CS

513 Gate Valve - Full Port - Heavy-Duty - Non Rising Stem - Bronze B62

125 SWP 200 WOG			
MSS-SP-80			
IPS Only	Cross Handle	Curb Stop Handle	
513T04	-	-	3/4"
513T05	-	-	1"
513T06	-	-	1-1/4"
513T07	-	-	1-1/2"
513T08	513T08X	513T08CS	2"
-	513T09X	-	2-1/2"
-	513T10X	-	3"

Replacement Handles Of Each Type Are Available.

Bronze Gate Valves

Gate Valves



519T

519

Gate Valve - Cast Brass - Non Rising Stem

Lead Free Version Available

200 WOG

MSS-SP-92

With Compression Ends For Copper Tube Pipe

MATCO-NORCA MODEL NUMBER	SIZE	CARTON QUANTITIES	
		INNER	MASTER
519T03	1/2" nominal	10	120
519T04	3/4" nominal	10	90
519T05	1" nominal	5	60

519TP

Gate Valve - Cast Brass - Compression With CPVC Stub-Outs

Lead Free Version Available

200 WOG



519TP

519T03TP	1/2"	12	72
519T04TP	3/4"	10	90

730

Quick Opening Gate Valve - Without Spring - Cast Bronze

125 SWP 200 WOG

IPS

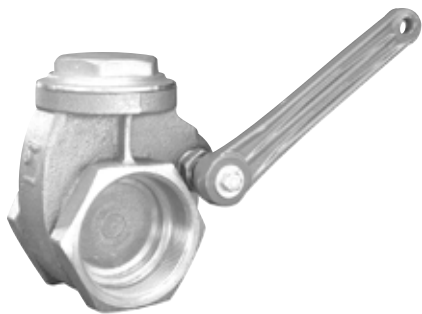

730T

730T03	1/2"	20	100
730T04	3/4"	20	100
730T05	1"	10	50
730T06	1-1/4"	10	50
730T07	1-1/2"	6	30
730T08	2"	4	20
730T09	2-1/2"	2	12
730T10	3"	2	10
730T11	4"	1	5

Bronze Y Strainers

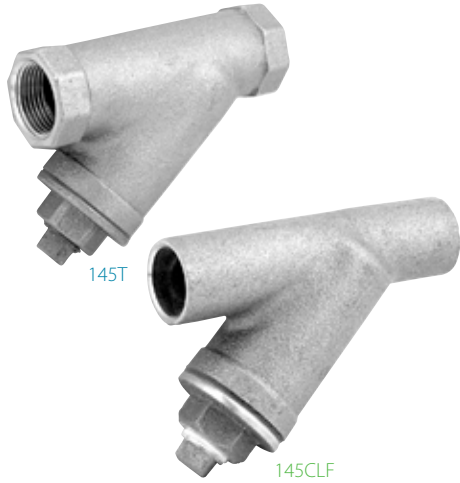

145

Y Strainer - Cast Bronze - With Brass Plug - 18 Mesh Stainless Steel Screen

MATCO-NORCA MODEL NUMBER	SIZE	CARTON QUANTITIES	
		INNER	MASTER
150 SWP 300 WOG			
Lead Free Version Available	Lead Free Only		
IPS	C x C	Size	Tap & Plug Size
145T01	-	1/4"	1/8"
145T02	-	3/8"	1/8"
145T03	145C03LF	1/2"	1/4"
145T04	145C04LF	3/4"	1/4"
145T05	145C05LF	1"	3/8"
145T06	145C06LF	1-1/4"	3/8"
145T07	145C07LF	1-1/2"	1/2"
145T08	145C08LF	2"	1/2"
145T09	-	2-1/2"	1-1/4"
145T10	-	3"	1-1/2"
Replacement Screens Available.			

Bronze Y Strainers



146

Y Strainer - Cast Bronze - 20 Mesh Stainless Steel Screen

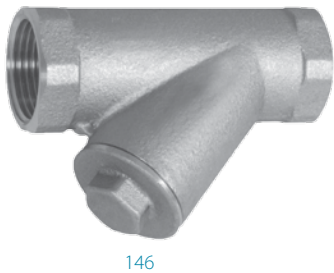

MATCO-NORCA MODEL NUMBER	SIZE	CARTON QUANTITIES
		INNER MASTER
200 WOG		
146T04	3/4"	8 64
146T05	1"	8 40

Swing Check Valves - Brass & Bronze

Brass & Bronze
Check Valves



521T



521CLF

521	MATCO-NORCA MODEL NUMBER		SIZE	CARTON QUANTITIES	
	200 WOG	125 SWP		INNER	MASTER
Swing Check Valve - Cast Brass - Brass Seat					
	Lead Free Version Available	Lead Free Only			
	IPS	C x C			
	521T02	-	3/8"	12	120
	521T03	521C03LF	1/2"	12	120
	521T04	521C04LF	3/4"	10	80
	521T05	521C05LF	1"	5	60
	521T06	521C06LF	1-1/4"	5	40
	521T07	521C07LF	1-1/2"	5	30
	521T08	521C08LF	2"	2	24
		Lead Free Version Available			
	521T09	521C09	2-1/2"	1	15
	521T10	521C10	3"	1	6
	521T11	521C11	4"	1	6

521N	MATCO-NORCA MODEL NUMBER		SIZE	CARTON QUANTITIES	
	200 WOG	125 SWP		INNER	MASTER
Swing Check Valve - Cast Brass - BUNA-N Seat					
	Lead Free Version Available				
	IPS				
	521N02		3/8"	1	120
	521N03		1/2"	10	120
	521N04		3/4"	10	80
	521N05		1"	5	60
	521N06		1-1/4"	1	40
	521N07		1-1/2"	5	20
	521N08		2"	1	24
	521N09		2-1/2"	1	15
	521N10		3"	1	6
	521N11		4"	1	6



521N

530	MATCO-NORCA MODEL NUMBER		SIZE	CARTON QUANTITIES	
	150 SWP	300 WOG		INNER	MASTER
Swing Check Valve - Cast Bronze B62 - Bronze Disc - Horizontal Pattern					
	Lead Free Version Available	Lead Free Only			
	IPS	IPS			
	530T02	-	3/8"	12	120
	530T03	-	1/2"	12	120
	-	530T04LF	3/4"	10	80
	-	530T05LF	1"	5	60
	-	530T06LF	1-1/4"	5	40
	-	530T07LF	1-1/2"	5	30
	530T08	-	2"	2	24
	Only Available in Standard				
	530T09		2-1/2"	1	15
	530T10		3"	1	6
	530T11		4"	1	6



530T

Check Valves Foot Valve



532T

532 **Swing Check Valve Y Pattern - Bronze B62**

150 SWP 300 WOG

MATCO-NORCA MODEL NUMBER	SIZE	CARTON QUANTITIES	
		INNER	MASTER
IPS			
532T03	1/2"	10	90
532T04	3/4"	10	80
532T05	1"	10	60
532T06	1-1/4"	5	30
532T07	1-1/2"	4	24
532T08	2"	2	16

525 **Inline Check Valve - Spring Loaded - Bronze B62 - 1/2 PSI Crack Pressure**

200 WOG



525T

**Lead Free
Version
Available**

**Lead Free
Only**

MATCO-NORCA MODEL NUMBER	SIZE	CARTON QUANTITIES	
		INNER	MASTER
IPS			
525T03	1/2"	10	100
525T04	3/4"	10	80
525T05	1"	6	60
525T06	1-1/4"	4	40
525T07	1-1/2"	5	30
525T08	2"	5	20
CXC			
525C03LF	1/2"	10	100
525C04LF	3/4"	10	80
525C05LF	1"	6	60
525C06LF	1-1/4"	4	40
525C07LF	1-1/2"	5	30
525C08LF	2"	5	20

527LF **Lead Free Foot Valve - Stainless Steel Screen - Bronze B62**

200 WOG



527LF

MATCO-NORCA MODEL NUMBER	SIZE	CARTON QUANTITIES	
		INNER	MASTER
IPS			
527T03LF	1/2"	1	100
527T04LF	3/4"	1	80
527T05LF	1"	1	60
527T06LF	1-1/4"	1	40
527T07LF	1-1/2"	1	30
527T08LF	2"	1	20

Bronze Check Valves
& Foot Valve

PVC Check Valve

Sump Pump Check Valve



523

PVC Inline Check Valve - 304 SS Spring - 1/2 PSI Crack Pressure - One Piece

Max 150 PSI @ 122° F

SOLVENT

THREADED

MATCO-NORCA MODEL NUMBER	SIZE	CARTON QUANTITIES INNER	CARTON QUANTITIES MASTER
523S03	1/2"	1	120
523S04	3/4"	1	120
523S05	1"	1	80
523S06	1-1/4"	1	60
523S07	1-1/2"	1	60
523S08	2"	1	40

529

Sump Pump Check Valve - Flexible Rubber Connections - Stainless Steel Clamps

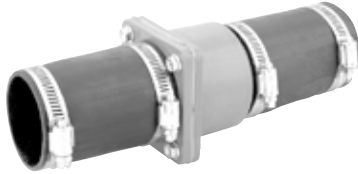

MATCO-NORCA MODEL NUMBER	SIZE	CARTON QUANTITIES INNER	CARTON QUANTITIES MASTER
529-0808	2" x 2"	10	50
529-0706	1-1/2" x 1-1/4"	10	50

PVC & Sump Pump Check Valves

Vacuum Breaker, Drip Valve & Back Flow Preventers



646AS

**MATCO-NORCA
MODEL NUMBER**

SIZE

**CARTON QUANTITIES
INNER MASTER**

Hose Bibb Vacuum Breaker - Brass - With Break-Away Set Screw

Lead Free Version Available
Conforms To ASSE 1011
3/4" Hose Connection



646AS4

MATCO-NORCA MODEL NUMBER	SIZE	CARTON QUANTITIES INNER	MASTER
646AS4	3/4" Brass Finish	12	144
646ASC	3/4" Chrome Plated	12	144

BDVLF

Lead Free Ball Drip Valve - Brass

MATCO-NORCA MODEL NUMBER	SIZE	CARTON QUANTITIES INNER	MASTER
BDV-03LF	1/2"	10	100
BDV-03LF	3/4"	10	100



BDVLF



BFPLF

Lead Free Back Flow Preventer - Brass - With Atmospheric Vent

Conforms to ASSE 1012
Max 175 PSI @ 250° F

IPS C x C



BFP-90LF

MATCO-NORCA MODEL NUMBER	SIZE	CARTON QUANTITIES INNER	MASTER
BFP-90-1/2LF	1/2" FIP	1	24
BFP-90-3/4LF	3/4" FIP	1	24



DCVLF

Lead Free Dual Check Back Flow Preventer - Brass

Conforms to ASSE 1024
Max 175 PSI @ 140° F

IPS

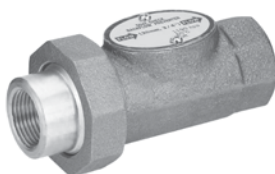

DCV-04LF

MATCO-NORCA MODEL NUMBER	SIZE	CARTON QUANTITIES INNER	MASTER
DCV-04LF	3/4"	1	24
DCV-05LF	1"	1	24

Low Pressure Valves

Brass Boiler Drains - Full Flow

Brass Boiler Drains



205F



205FF

205F Boiler Drain - 3/4" Hose Outlet - Angle Spout - With Stuffing Box

Lead Free Version Available

125 PSI

MATCO-NORCA MODEL NUMBER	SIZE	CARTON QUANTITIES INNER	CARTON QUANTITIES MASTER
MIP	Inlet		
205F03*	1/2"	12	72
205F04	3/4"	12	72
* 1/2" MIP & 1/2" SWT Inlet			
FIP			
205FF3	1/2"	12	72
205FF4	3/4"	12	72



205TM



205TF



205TR3

205 Boiler Drain - 3/4" Hose Outlet - With Stuffing Box

Lead Free Version Available

125 PSI

MATCO-NORCA MODEL NUMBER	SIZE	CARTON QUANTITIES INNER	CARTON QUANTITIES MASTER
MIP	FIP	Inlet	
205TM3*	205TF3	1/2"	12
205TM4	205TF4	3/4"	12
* 1/2" MIP & 1/2" SWT Inlet			
CTS Compression With Nut & Ferrule			
205TR3	1/2"	12	72



205CM Boiler Drain - 3/4" Hose Outlet - Angle Spout - With Stuffing Box

125 PSI



205CM3

MATCO-NORCA MODEL NUMBER	SIZE	CARTON QUANTITIES INNER	CARTON QUANTITIES MASTER
205CM3	1/2" Male Copper Sweat	12	72



204 Boiler Drain - 3/4" Hose Outlet - Less Stuffing Box

Lead Free Version Available

125 PSI



204



204LS3

MATCO-NORCA MODEL NUMBER	SIZE	CARTON QUANTITIES INNER	CARTON QUANTITIES MASTER
MIP	FIP	Inlet	
204TM3*	204TF3	1/2"	12
204TM4	204TF4	3/4"	12
204LS3*	Long Shank 1/2" MIP With Locknut		12
204LS3P	Long Shank 1/2" PEX x Chamfer For Cone Connection With Locknut		12
* 1/2" MIP & 1/2" SWT Inlet			

Stop Valves - Globe Style

		MATCO-NORCA MODEL NUMBER	SIZE	CARTON QUANTITIES	
				INNER	MASTER
	201	Stop Valve - Globe Style - Brass - Soft Seat			
		125 PSI			
		Lead Free Only		Lead Free Version Available	
IPS	C x C	IPS With Cross Handle			
201T03LF	201C03LF	201X03	1/2"	12	72
201T04LF	201C04LF	201X04	3/4"	12	72
Replacement Handles Available.					

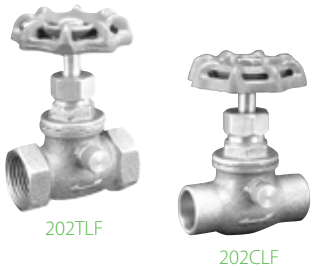

202LF Stop & Waste Valve - Globe Style - Brass - Soft Seat

		125 PSI			
IPS	C x C				
202T03LF	202C03LF		1/2"	12	72
202T04LF	202C04LF		3/4"	12	72

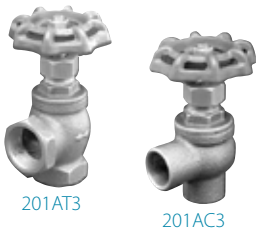

201A Angle Stop Valve - Globe Style - Brass - Soft Seat

		Lead Free Version Available			
		125 PSI			
		201AT3	1/2" IPS	12	72
		201AC3	1/2" C x C	12	72



201/202CMLF Lead Free Stop & Waste Valve - Brass Nut & Ferrule

		125 PSI			
With Compression Ends For Copper Tube Pipe					
With Waste Cap					
		201CMPLF	202CMPLF	1/2" nominal	12
		201CM4LF	202CM4LF	3/4" nominal	12

Aztec Low Pressure Valves Sillcocks

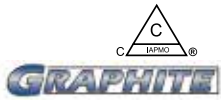

AZ203TF



AZ205C034

AZ205TF

AZ205TM



AZ206C034

AZ206T



AZ206T/VB



AZ206LK

**MATCO-NORCA
MODEL NUMBER**

SIZE

**CARTON QUANTITIES
INNER MASTER**

AZ203

Aztec Bent Nose Garden Valve With Stuffing Box - Brass - Graphite Packing

Lead Free Version Available

125 PSI 3/4" Hose Outlet

Inlet

AZ203TF3	1/2" FIP	12	72
AZ203TF4	3/4" FIP	12	72
AZ203TF5	1" FIP	12	72

AZ205

Aztec Boiler Drain With Stuffing Box - Brass - Graphite Packing

Lead Free Version Available

125 PSI 3/4" Hose Outlet

AZ205C034	3/4" Copper Fitting & 1/2" Copper Sweat	12	72
AZ205TF3	1/2" FIP	12	72
AZ205TF4	3/4" FIP	12	72
AZ205TM3	1/2" MIP	12	72
AZ205TM4	3/4" MIP	12	72

AZ206

Aztec Sillcock With Stuffing Box - Brass - Graphite Packing

Lead Free Version Available

125 PSI 3/4" Hose Outlet

Inlet

AZ206C034	3/4" Copper Fitting & 1/2" Copper Sweat	12	72
AZ206T03	1/2" FIP	12	72
AZ206T04	3/4" FIP	12	72

AZ206/VB

Aztec Sillcock With Vacuum Breaker - Brass - Graphite Packing

Lead Free Version Available

125 PSI 3/4" Hose Outlet

AZ206T03/VB	1/2" FIP	12	72
AZ206T04/VB	3/4" FIP	12	72

AZ206/LK

Aztec Sillcock - Loose Key - Brass - Graphite Packing

Lead Free Version Available

125 PSI 3/4" Hose Outlet

AZ206T03LK	1/2" FIP	12	72
AZ206T04LK	3/4" FIP	12	72

Aztec Low Pressure Valves

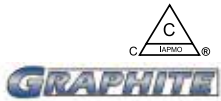

AZ646R

MATCO-NORCA MODEL NUMBER	SIZE	CARTON QUANTITIES INNER MASTER	
AZ646R Aztec Hose Bibb With Tee Handle - Graphite Packing			
Lead Free Version Available 125 PSI 3/4" Hose Outlet			
AZ646R03	1/2" MIP	12	72
AZ646R04	3/4" MIP	12	72



AZ207C04



AZ207TF



AZ207TM



AZ207TR

MATCO-NORCA MODEL NUMBER	SIZE	CARTON QUANTITIES INNER MASTER	
AZ207 Aztec No Kink Hose Bibb - Brass - Graphite Packing			
Lead Free Version Available 125 PSI 3/4" Hose Outlet			
AZ207C04	3/4" Copper Fitting and 1/2" Copper Sweat	12	72
AZ207TF3	1/2" FIP	12	72
AZ207TF4	3/4" FIP	12	72
AZ207TM3	1/2" MIP	12	72
AZ207TM4	3/4" MIP	12	72
AZ207TR3	1/2" CTS Compression With Nut & Ferrule	12	72



AZ207TFLK



AZ207TMLK

MATCO-NORCA MODEL NUMBER	SIZE	CARTON QUANTITIES INNER MASTER	
AZ207 Aztec Loose Key Valve - No Kink - Brass - Graphite Packing			
Lead Free Version Available 125 PSI 3/4" Hose Outlet			
AZ207TF3LK	1/2" FIP	12	72
AZ207TF4LK	3/4" FIP	12	72
AZ207TM3LK	1/2" MIP	12	72
AZ207TM4LK	3/4" MIP	12	72



AZ207TF/VB



AZ207TM/VB

MATCO-NORCA MODEL NUMBER	SIZE	CARTON QUANTITIES INNER MASTER	
AZ207 Aztec No Kink Valve With Vacuum Breaker - Brass - Graphite Packing			
Lead Free Version Available 125 PSI 3/4" Hose Outlet			
AZ207TF3/VB	1/2" FIP	12	72
AZ207TF4/VB	3/4" FIP	12	72
AZ207TM3/VB	1/2" MIP	12	72
AZ207TM4/VB	3/4" MIP	12	72

Aztec Low Pressure Valves

Hose Bibbs

Ball Valve Hose Bibbs



646R

MATCO-NORCA MODEL NUMBER SIZE CARTON QUANTITIES INNER MASTER

Hose Bibb - Male - Cast Brass - 3/4" Hose Outlet

Lead Free Version Available

125 PSI

MATCO-NORCA MODEL NUMBER	SIZE	CARTON QUANTITIES INNER	CARTON QUANTITIES MASTER
646R03	1/2" MIP & 1/2" SWT x 3/4" Hose	12	72
646R04	3/4" MIP x 3/4" Hose	12	72
646R05	1" MIP x 1" Hose	12	48
P646R03H	Replacement Handle for 1/2" & 3/4"	1	100



646BV

Ball Valve Hose Bibb - Forged Brass - 1/4 Turn - 3/4" Hose Outlet

Lead Free Version Available

125 PSI

MATCO-NORCA MODEL NUMBER	SIZE	CARTON QUANTITIES INNER	CARTON QUANTITIES MASTER
646BV03	1/2" MIP & 1/2" SWT	12	24
646BV04	3/4" MIP	12	24
P646BVC43H	Replacement Handles	1	1000



207









No Kink Hose Bibb - 3/4" Hose Outlet

Lead Free Version Available

125 PSI

MATCO-NORCA MODEL NUMBER	SIZE	CARTON QUANTITIES INNER	CARTON QUANTITIES MASTER
MIP			
207TM3	1/2"	12	72
207TM4	3/4"	12	72
FIP			
207TF3	1/2"	12	72
207TF4	3/4"	12	72
Sweat			
207C04	1/2" Sweat & 3/4" Copper Fitting	12	72

Plumbing Specialty Brass Hose Bibbs

		MATCO-NORCA MODEL NUMBER	SIZE	CARTON QUANTITIES	
				INNER	MASTER
		FY	Hose Bibb - Brass - Tee Handles		
			Lead Free Version Available		
			125 PSI		
	FY-675	FY-675	Chrome Plated Hose Bibb Plain End Outlet 1/2" FIP Inlet - Flanged	12	72
	FY-680	FY-680	Chrome Plated Hose Bibb 3/4" Hose End Outlet 1/2" FIP Inlet - Flanged	12	72
	FY-681	FY-681	Chrome Plated Hose Bibb Plain End Outlet 1/2" MIP Inlet - Adj. Flange	12	72
	FY-682	FY-682	Chrome Plated Hose Bibb 3/4" Hose End Outlet 1/2" MIP Inlet - Adj. Flange	12	72
	FY-685	FY-685*	Chrome Plated Hose Bibb 3/4" Hose End Outlet 1/2" FIP Inlet	12	72
	FY-690	FY-690	Chrome Plated Hose Bibb 3/4" Hose End Outlet 1/2" MIP Inlet	12	72
	FY-691	FY-691	Chrome Plated Hose Bibb Plain End Outlet 1/2" MIP Inlet	12	72
	FY-691PB*	FY-691PB*	Polished Brass Hose Bibb (not shown) Plain End Outlet 1/2" MIP Inlet	12	72
	FY-692	FY-692	Rough Brass Hose Bibb Plain End Outlet 1/2" MIP Inlet	12	72
	FY-695	FY-695	Chrome Plated Hose Bibb 3/4" Hose End Outlet 3/4" MIP Inlet	12	144

*** Only Available in Standard**

Brass Sillcocks Garden Valves

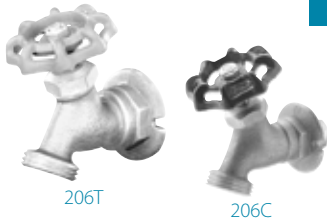

206T

206C



206

Sillcock - 3/4" Hose Outlet - Brass Body

Lead Free Version Available

125 PSI

MATCO-NORCA MODEL NUMBER		SIZE	CARTON QUANTITIES	
			INNER	MASTER
FIP	Sweat	Inlet		
206T03	206C03	1/2"	12	72
206T04	206C04	3/4"	12	72



206T03H

206H

Sillcock - Heavy Pattern - 3/4" Hose Outlet - Brass Body - With Stuffing Box

Lead Free Version Available

125 PSI

MATCO-NORCA MODEL NUMBER		SIZE	CARTON QUANTITIES	
			INNER	MASTER
FIP		Inlet		
206T03H		1/2" FIP	12	72
206T04H		3/4" FIP	12	72



206VB

206VB

Sillcock - With ASSE 1011 Vacuum Breaker - 3/4" Hose Outlet

Lead Free Version Available

125 PSI

MATCO-NORCA MODEL NUMBER		SIZE	CARTON QUANTITIES	
			INNER	MASTER
FIP		Inlet		
206T03VB		1/2" FIP	12	72



206HLK

206HLK

Sillcock - Loose Key - Heavy Pattern - Female - 3/4" Hose Outlet

125 PSI

MATCO-NORCA MODEL NUMBER		SIZE	CARTON QUANTITIES	
			INNER	MASTER
FIP		Inlet		
206T03HLK		1/2" FIP	12	72
206T04HLK		3/4" FIP	12	72



203TF4

203IF4

203TL4

203

Garden Valve - Bent Nose - Female - 3/4" Hose Outlet







Lead Free Version Available

125 PSI

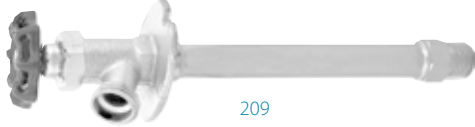
MATCO-NORCA MODEL NUMBER		SIZE	CARTON QUANTITIES	
			INNER	MASTER
Bent Nose		Inlet		
203TF3		1/2" FIP	12	72
203TF4		3/4" FIP	12	72
203TF5		1" FIP	12	72
Inverted Nose				
203IF4		3/4" FIP	12	72
Loose Key				
203TL3		1/2"	12	72
203TL4		3/4"	12	72
203TL5		1"	12	72
Key Only				
203TLK			1	200

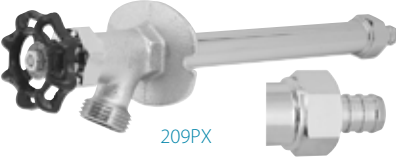
203TLK

Frost Free Sillcocks

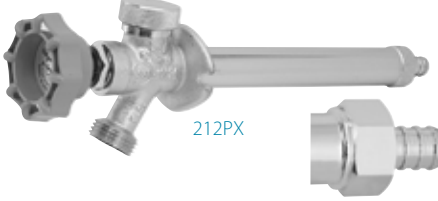
UPC	MATCO-NORCA MODEL NUMBER	SIZE	CARTON QUANTITIES		
			INNER	MASTER	
 	209	Frost Free Sillcock - 3/4" Hose Outlet			
		125 PSI			
		Lead Free Version Available	Only Available in Standard		
		1/2" MIP & 1/2" SWT Inlet	Length		
		209004	4"	1	24
		209006	6"	1	24
		209008	8"	1	24
		209010	10"	1	24
		209012	12"	1	24
		209014	14"	1	24
		With Loose Key			
		209008LK	8"	1	24
		209010LK	10"	1	24
		209012LK	12"	1	24
		3/4" MIP & 1/2" FIP Inlet	Length		
	209404	4"	1	24	
	209406	6"	1	24	
	209408	8"	1	24	
	209410	10"	1	24	
	209412	12"	1	24	
	209414	14"	1	24	
 	209PX	Frost Free Sillcock - Pex - 3/4" Hose Outlet			
		125 PSI			
		1/2" PEX Inlet			
		209004PX	4"	1	24
		209006PX	6"	1	24
		209008PX	8"	1	24
		209010PX	10"	1	24
	209012PX	12"	1	24	
 	212	Frost Free Sillcock - Anti Syphon - 3/4" Hose Outlet			
		Lead Free Version Available			
		125 PSI			
		1/2" MIP & 1/2" SWT Inlet	Length		
		212004	4"	1	24
		212006	6"	1	24
		212008	8"	1	24
		212010	10"	1	24
		212012	12"	1	24
		212014	14"	1	24
	212KIT	- Vacuum Breaker Kit Available.			
 	212PX	Frost Free Sillcock - Pex - Anti Syphon - 3/4" Hose Outlet			
		Lead Free Version Available			
		125 PSI			
		1/2" PEX Inlet			
		212004PX	4"	1	24
		212006PX	6"	1	24
		212008PX	8"	1	24
		212010PX	10"	1	24
	212012PX	12"	1	24	
	212014PX	14"	1	24	

Frost Free Sillcocks

Steam Radiator Angle & Gate Valves Slip Nuts



BARVY



BARVYN



BARV



NT



SGV



BSGV

	MATCO-NORCA MODEL NUMBER	SIZE	CARTON QUANTITIES	
			INNER	MASTER
BARVY	Steam Radiator Angle Valve - Brass - Heavy Pattern			
	BARVY-0500	1/2" FIP With Nut & Tailpiece	10	60
	BARVY-0750	3/4" FIP With Nut & Tailpiece	6	48
	BARVY-1000	1" FIP With Nut & Tailpiece	4	36
	BARVY-1250	1-1/4" FIP With Nut & Tailpiece	2	24
	BARVY-1500	1-1/2" FIP With Nut & Tailpiece	2	16
BARVYN	Steam Radiator Angle Valve - Brass			
	BARVY-1001N	1-1/2" FIP With Nut & Tailpiece	4	36
	BARVY-1251N	1-1/4" FIP With Nut & Tailpiece	4	24
BARV	Steam Radiator Angle Valve - Bronze - Heavy Pattern			
	BARV-0500	1/2" FIP With Nut & Tailpiece	10	60
	BARV-0750	3/4" FIP With Nut & Tailpiece	6	48
	BARV-1000	1" FIP With Nut & Tailpiece	4	36
	BARV-1250	1-1/4" FIP With Nut & Tailpiece	2	24
	BARV-1500	1-1/2" FIP With Nut & Tailpiece	2	18
	BARV-2000	2" FIP With Nut & Tailpiece	1	8
NT	Slip Nuts - Chrome			
	NT-100	1" Nut & Tail Piece For BARVY-1000 & BARV-1000	10	100
	NT-125	1-1/4" Nut & Tail Piece For BARVY-1250 & BARV-1250	10	100
SGV	Steam Radiator Gate Valve - Brass			
	SGV-1001	1" FIP With Nut & Tailpiece	4	36
	SGV-1251	1-1/4" FIP With Nut & Tailpiece	4	24
BSGV	Steam Radiator Gate Valve - Bronze - Heavy Pattern			
	BSGV-0750	3/4" FIP With Nut & Tailpiece	6	48
	BSGV-1000	1" FIP With Nut & Tailpiece	4	36
	BSGV-1250	1-1/4" FIP With Nut & Tailpiece	4	24
	BSGV-1500	1-1/2" FIP With Nut & Tailpiece	4	24

Radiator Valve & Air Valves Drain Valve, Convector Valve



AHV

AHV	MATCO-NORCA MODEL NUMBER		SIZE	CARTON QUANTITIES	
	MODEL NUMBER	SIZE		INNER	MASTER
Angle Hot Water Radiator Valve - Brass					
	AHV-0500	1/2" FIP With Nut & Tailpiece		1	60
	AHV-0750	3/4" FIP With Nut & Tailpiece		1	60
	AHV-1000	1" FIP With Nut & Tailpiece		4	36
	AHV-1250	1-1/4" FIP With Nut & Tailpiece		2	24
	AHV-0500C	1/2" SWT With Nut & Tailpiece		1	60
	AHV-0750C	3/4" SWT With Nut & Tailpiece		1	60



CK-100



KEY-100

CK/KEY	Coin Key Air Valve				
	CK-100	1/8" Coin Key Air Valve Nickle Plated		100	1000
	CKU-102	1/8" Key Air Valve		100	1000
	KEY-100	1/8" Key For Air Valve		100	2000



HAVS01



HAVA00



HAV-125

HAV	Steam Air Vents - Chrome Plated				
	HAV-125	1/8" Auto Vent HW & Steam		50	500
	HAVA00	1/8" Angle		12	72
	HAVADJ00	1/8" Adjustable Angle		12	72
	HAVS00	1/8" Straight		12	72
	HAVS01	1/4" Straight		12	72
	HAVS0403	3/4" x 1/2" Straight		12	72



AVA-125



AVS-125



ADJ-180

AVA/AVS/ADJ	Chrome Plated Steam Air Valves				
	AVA-125	1/8" Angle - MIP		12	144
	AVS-125	1/8" Straight - MIP		1	144
	AVS-250	1/4" Straight - MIP		1	144
	AVS-750	3/4" MIP & 1/2" FIP Straight		1	144
	ADJ-180	1/8" Angle MIP Adjustable		12	144



205WH4

205WH	Water Heater Drain Valve - Brass - Heavy Pattern				
	Lead Free Version Available				
	205WH4	3/4" x 2-1/4" Long 3/4" MIP & 1/2" FIP Inlet		12	72























BCV

BCV	Convector Valve - Bronze				
	BCV-1000	1" FIP With FIP Union		2	24
	BCV-1250	1-1/4" FIP With FIP Union		2	20

Heating Valves
& Specialties

Multi-Turn Supply Valves

Multi-Turn
Supply Valves

		MATCO-NORCA MODEL NUMBER	SIZE	CARTON QUANTITIES			
				INNER	MASTER		
	29LF	Lead Free Supply Valves - Oval Handle With Compression Outlet - Angle					
		125 PSI					
			29-1001LF	CP 3/8" FIP x 3/8" OD Compression	10	200	
			29-1003PXL	CP 1/2" FIP x 3/8" OD Compression	10	200	
			29-1003PXLF	CP 1/2" PEX x 3/8" OD Compression	10	200	
			29-1003BLF	Unplated 1/2" FIP x 3/8" OD Compression	10	200	
			29-1009LF	CP 1/2" SWT x 3/8" OD Compression	10	200	
			29-1009BLF	Unplated 1/2" SWT x 3/8" OD Compression	10	200	
			29-1019LF	CP 5/8" OD Compression x 3/8" OD Compression	10	200	
			29-1019CPVCLF	Unplated 5/8" OD Compression x 3/8" OD Compression	10	200	
	29-1019CPVCLF	CP 5/8" OD CPVC x 3/8" OD	10	200			
	29LF	Lead Free Supply Valves - Oval Handle With Compression Outlet - Straight					
		125 PSI					
			29-1002LF	CP 3/8" FIP x 3/8" OD Compression	10	200	
			29-1004PXL	CP 1/2" FIP x 3/8" OD Compression	10	200	
			29-1004PXLF	CP 1/2" PEX x 3/8" OD Compression	10	200	
			29-1010LF	CP 1/2" SWT x 3/8" OD Compression	10	200	
			29-1010BLF	Unplated 1/2" SWT x 3/8" OD Compression	10	200	
			29-1014LF	CP 5/8" OD Compression x 3/8" OD Compression	10	200	
			29-1014CPVCLF	CP 5/8" OD CPVC x 3/8" OD Straight Stop	10	200	
			29-1020LF	CP 1/2" OD Compression x 3/8" OD Compression	10	200	
	29-1575LF	CP 5/8" OD Compression x 5/8" OD Compression	10	200			
	29LF	Lead Free Supply Valves - Oval Handle With Compression Outlet With 5" Extension and Bell Escutcheon					
		125 PSI					
			29-1040LF	CP 1/2" SWT x 3/8" OD Compression - Angle	10	100	
	29-1041LF	CP 1/2" SWT x 3/8" OD Compression - Straight	10	100			
	29LF	Lead Free Supply Valves - Oval Handle With Dual Compression Outlet - Angle					
		125 PSI					
			29-2001LF	CP 5/8" OD x 3/8" OD x 3/8" OD	10	200	
			29-2001BLF	Unplated 5/8" OD x 3/8" OD x 3/8" OD	10	200	
	29-2001PXL	CP 1/2" PEX x 3/8" OD Compression x 3/8" OD Compression	10	200			

Quarter Turn Supply Valves

		MATCO-NORCA MODEL NUMBER	SIZE	CARTON QUANTITIES INNER MASTER		
	NSF	UPC	26LF	Lead Free Supply Valves - Oval Handle - With Compression Outlet - Angle		
			125 PSI			
			26-1001LF	CP 3/8" FIP x 3/8" OD Compression	10	200
			26-1003LF	CP 1/2" FIP x 3/8" OD Compression	10	200
			26-1003PXLF	CP 1/2" PEX x 3/8" OD Compression	10	200
			26-1009LF	CP 1/2" Sweat x 3/8" OD Compression	10	200
			26-1009BLF	Unplated 1/2" Sweat x 3/8" OD Compression	10	200
			26-1019LF	CP 5/8" OD Compression x 3/8" OD Compression	10	200
			26-1019BLF	Unplated 5/8" OD Compression x 3/8" OD Compression	10	200
			26-1019CPVCLF	CP 5/8" OD CPVC Compression x 3/8" OD Compression	10	200
	NSF	UPC	26LF	Lead Free Supply Valves - Oval Handle - With Compression Outlet - Straight		
			125 PSI			
			26-1002LF	CP 3/8" FIP x 3/8" OD Compression	10	200
			26-1004LF	CP 1/2" FIP x 3/8" OD Compression	10	200
			26-1004PXLF	CP 1/2" PEX x 3/8" OD Compression	10	200
			26-1010LF	CP 1/2" Sweat x 3/8" OD Compression	10	200
			26-1010BLF	Unplated 1/2" Sweat x 3/8" OD Compression	10	200
			26-1012PXLF	CP 1/2" PEX x 1/2" PEX	10	200
			26-1014LF	CP 5/8" OD Compression x 3/8" OD Compression	10	200
			26-1014PVCLF	CP 5/8" OD CPVC Compression x 3/8" OD Compression	10	200
	NSF	UPC	26LF	Lead Free Supply Valves - Oval Handle - With Compression Outlet		
			125 PSI	With 5" Extension and Bell Escutcheon		
			26-1041LF	CP 1/2" Sweat x 3/8" OD Compression - Angle	10	100
		26-1040LF	CP 1/2" Sweat x 3/8" OD Compression - Straight	10	100	
	NSF	UPC	26LF	Lead Free Supply Valves - Oval Handle - With Dual Compression Outlet - Angle		
			125 PSI			
			26-2001LF	CP 5/8" OD Compression x 3/8" OD Compression	10	200
		26-2001BLF	Unplated 5/8" OD Compression x 3/8" OD Compression	10	200	
	NSF	UPC	25LF	Lead Free Supply Valves - Lever Handle - With Compression Outlet - Straight		
			25-2000LF	CP Retro-Fit 3/8" OD Captured Nut x 3/8" OD Compression	10	200

Quarter Turn Supply Valves

Miscellaneous: Float Valve, Float Rod, Evaporator Cooler Float Valve, Meter Valve

**MATCO-NORCA
MODEL NUMBER**

SIZE

**CARTON QUANTITIES
INNER MASTER**

FV Float Valve - Bronze

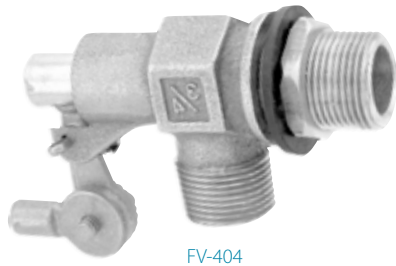

FV-404

Straight Thread Male Inlet - Plain Outlet

Rod Size

FV-303P	1/2"	1/4" x 20"	12	72
FV-404P	3/4"	1/4" x 20"	6	36

Straight Thread Male Inlet - Straight Thread Male Outlet

FV-303	1/2"	1/4" x 20"	1	72
FV-404	3/4"	1/4" x 20"	6	48

Female Inlet - Plain Outlet

FV-505	1"	5/16" x 18"	4	36
FV-606	1-1/4"	3/8" x 16"	2	20
FV-707	1-1/2"	3/8" x 16"	2	16
FV-808	2"	3/8" x 16"	2	12

FR Float Rod - Brass



FR12-1

Length Thread Pattern

FR12-1	12"	1/4" - 20	5	500
FR12-15	12"	5/16" - 18	5	250
FR12-2	12"	3/8" - 16	1	200

EFV Evaporator Cooler Float Valve

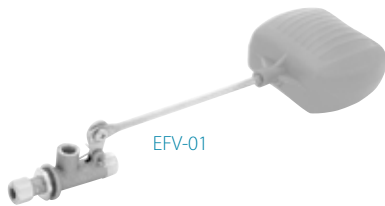

EFV-01

EFV-01	1/4" Compression Inlet x 1/4" FIP Outlet	20	80
--------	--	----	----

434LF Lead Free Meter Valve - Brass



434-0404LF

434-0404DLF

Angle Valve - Flare x IPS

434-0403LF	3/4" FL x 1/2" IPS	6	36
434-0404LF	3/4" FL x 3/4" IPS	6	36
434-0504LF	1" FL x 3/4" IPS	6	24

Angle Valve With Drain - Flare x IPS

434-0404DLF	3/4" FL x 3/4" IPS	6	36
434-0505DLF	1" FL x 1" IPS	4	24

Miscellaneous: Oil Tank Valve, Oil Barrel Faucet, Balancing Valves, Circulator Flange Kits

	MATCO-NORCA MODEL NUMBER	SIZE	CARTON QUANTITIES	
			INNER	MASTER
 <p>OTV-100</p> <p>OTV-200</p>	OTV	Oil Tank Valve - Brass - Hard Seat		
	OTV-100	1/2" MIP X 3/8" MIP	6	72
	OTV-200	1/2" MIP X 3/8" FL	1	72
 <p>59DB04</p>	59	Oil Barrel Faucet - Locking Lever		
	59DB04	3/4" MIP x Plain Spout - Zamac	10	100
 <p>759SDS</p>	759SDS	Ball Style Balancing Valve		
		Lead Free Version Available		
		600 WOG		
	759C04SDS	3/4" C x C With Screwdriver Stop	10	60
 <p>PBVC04C</p>	PBVC	Brass Purge & Balancing Valve		
	PBVC04C	3/4" SWT x 1/2" FIP With Drain Outlet	12	60
 <p>CIF04</p>	CIF	Circulator Flange Kits - Cast Iron - With Bolts & Nuts		
		Complete with 2 Flanges, 4 Bolts, 4 Nuts		
	CIF04	3/4"	1	30
	CIF05	1"	1	30
	CIF06	1-1/4"	1	30

Miscellaneous

Carbon Steel Valves

Carbon Steel Valves



Stainless Steel Valves



Stainless Steel Valves

Valves

Carbon & Stainless Steel Valve Part # Breakdown

20SSFL08D

20 SS FL 08 D

Choose Series	
15	One Piece, Reduced Port
20	Two Piece, Full Port
25	Two Piece, Reduced Port
30	Three Piece, Full Port
40	Gate Valve
50	Globe Valve
60	Check Valve
70	Y Strainer

Choose Material	
CS	Carbon Steel
SS	Stainless Steel

Select Style	
D	Direct Mounting Pad
FL	Flange
M	Mounting Pad
SW	Socket Weld
TH	Threaded

Part #	Size
01	1/4"
02	3/8"
03	1/2"
04	3/4"
05	1"
06	1-1/4"
07	1-1/2"
08	2"
09	2-1/2"
10	3"
11	4"
13	6"
14	8"
15	10"



Carbon & Stainless Steel Ball Valves

Carbon & Stainless
Steel Ball Valves



15SSTH

MATCO-NORCA MODEL NUMBER **SIZE** **WEIGHT**

316 Stainless Steel Threaded Ball Valve - One Piece - Reduced Port

1000 WOG

Locking Handle

15SSTH01	1/4"	0.1
15SSTH02	3/8"	0.2
15SSTH03	1/2"	0.4
15SSTH04	3/4"	0.6
15SSTH05	1"	0.8
15SSTH06	1-1/4"	1.3
15SSTH07	1-1/2"	1.8
15SSTH08	2"	2.9

20SSFLD



316 Stainless Steel Flanged Ball Valve - Two Piece - Full Port

Class 150 **API 607 Fire Safe Approved - Up to 6"**

Locking & Anti-Static Device

ISO 5211 Direct Mount

20SSFL03D	1/2"	3.7
20SSFL04D	3/4"	4.6
20SSFL05D	1"	7.1
20SSFL06D	1-1/4"	8.2
20SSFL07D	1-1/2"	13.2
20SSFL08D	2"	17.6
20SSFL09D	2-1/2"	32.0
20SSFL10D	3"	40.2
20SSFL11D	4"	63.9
20SSFL13D	6"	160.0
20SSFL14D	8"	269.0
20SSFL15D	10"	315.3

20CSFLD



Carbon Steel Flanged Ball Valve - Two Piece - Full Port

Class 150 **API 607 Fire Safe Approved - Up to 6"**

Locking & Anti-Static Device

ISO 5211 Direct Mount

20CSFL03D	1/2"	3.7
20CSFL04D	3/4"	4.6
20CSFL05D	1"	7.1
20CSFL06D	1-1/4"	8.2
20CSFL07D	1-1/2"	13.2
20CSFL08D	2"	17.6
20CSFL09D	2-1/2"	32.0
20CSFL10D	3"	40.2
20CSFL11D	4"	63.9
20CSFL13D	6"	160.0
20CSFL14D	8"	269.0
20CSFL15D	10"	315.3

Carbon & Stainless Steel Ball Valves



20SSTHM

20SSTHM

316 Stainless Steel Threaded Ball Valve - Two Piece - Full Port

1000 WOG

Locking Handle

Mounting Pad

MATCO-NORCA MODEL NUMBER	SIZE	WEIGHT
20SSTH01M	1/4"	0.5
20SSTH02M	3/8"	0.5
20SSTH03M	1/2"	0.7
20SSTH04M	3/4"	1.0
20SSTH05M	1"	1.7
20SSTH06M	1-1/4"	2.5
20SSTH07M	1-1/2"	3.9
20SSTH08M	2"	5.9
20SSTH09M	2-1/2"	12.4
20SSTH10M	3"	16.5

25SSTHM

316 Stainless Steel Threaded Ball Valve - Two Piece - Reduced Port

1/4" - 1" 2000 WOG 1-1/4" - 2" 1500 WOG

Locking Handle

Mounting Pad



25SSTHM

25SSTH01M	1/4"	0.7
25SSTH02M	3/8"	0.7
25SSTH03M	1/2"	0.7
25SSTH04M	3/4"	1.4
25SSTH05M	1"	1.8
25SSTH06M	1-1/4"	3.2
25SSTH07M	1-1/2"	4.1
25SSTH08M	2"	6.0

25CSTHM

Carbon Steel Threaded Ball Valve - Two Piece - Reduced Port

1/4" - 1" 2000 WOG 1-1/4" - 2" 1500 WOG

Locking Handle

Mounting Pad



25CSTHM

25CSTH01M	1/4"	0.7
25CSTH02M	3/8"	0.7
25CSTH03M	1/2"	0.7
25CSTH04M	3/4"	1.4
25CSTH05M	1"	1.8
25CSTH06M	1-1/4"	3.2
25CSTH07M	1-1/2"	4.1
25CSTH08M	2"	6.0

Stainless Steel Ball Valves

Stainless Steel Ball Valves



MATCO-NORCA MODEL NUMBER	SIZE	WEIGHT
30SSTH 316 Stainless Steel Threaded Ball Valve - Three Piece - Full Port		
1000 WOG Locking Handle		
30SSTH01	1/4"	0.8
30SSTH02	3/8"	0.8
30SSTH03	1/2"	1.1
30SSTH04	3/4"	1.5
30SSTH05	1"	2.2
30SSTH06	1-1/4"	3.5
30SSTH07	1-1/2"	5.5
30SSTH08	2"	7.7
30SSTH09	2-1/2"	14.8
30SSTH10	3"	20.9
30SSTH11	4"	42.1



30SSSW 316 Stainless Steel Socket Weld Ball Valve - Three Piece - Full Port		
1000 WOG Locking Handle		
30SSSW01	1/4"	0.8
30SSSW02	3/8"	0.8
30SSSW03	1/2"	1.1
30SSSW04	3/4"	1.5
30SSSW05	1"	2.2
30SSSW06	1-1/4"	3.5
30SSSW07	1-1/2"	5.5
30SSSW08	2"	7.7
30SSSW09	2-1/2"	14.8
30SSSW10	3"	20.9
30SSSW11	4"	42.1



30SSSTM 316 Stainless Steel Threaded Ball Valve - Three Piece - Full Port		
1000 WOG Locking Handle ISO 5211 Mounting Pad		
30SSSTM01M	1/4"	0.8
30SSSTM02M	3/8"	0.8
30SSSTM03M	1/2"	1.1
30SSSTM04M	3/4"	1.5
30SSSTM05M	1"	2.3
30SSSTM06M	1-1/4"	3.6
30SSSTM07M	1-1/2"	5.3
30SSSTM08M	2"	7.7
30SSSTM09M	2-1/2"	14.8
30SSSTM10M	3"	21.6
30SSSTM11M	4"	42.3

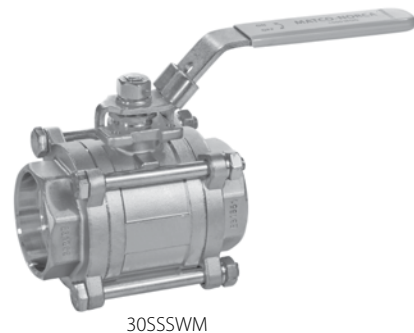

30SSWWM 316 Stainless Steel Socket Weld Ball Valve - Three Piece - Full Port		
1000 WOG Locking Handle ISO 5211 Mounting Pad		
30SSWWM01M	1/4"	0.8
30SSWWM02M	3/8"	0.8
30SSWWM03M	1/2"	1.1
30SSWWM04M	3/4"	1.5
30SSWWM05M	1"	2.3
30SSWWM06M	1-1/4"	3.6
30SSWWM07M	1-1/2"	5.3
30SSWWM08M	2"	7.7
30SSWWM09M	2-1/2"	14.8
30SSWWM10M	3"	21.6
30SSWWM11M	4"	42.3

Carbon Steel Ball Valves



30CSTH

30CSTH

Carbon Steel Threaded Ball Valve - Three Piece - Full Port

1000 WOG

Locking Handle

MATCO-NORCA MODEL NUMBER	SIZE	WEIGHT
30CSTH01	1/4"	0.8
30CSTH02	3/8"	0.8
30CSTH03	1/2"	1.1
30CSTH04	3/4"	1.5
30CSTH05	1"	2.2
30CSTH06	1-1/4"	3.5
30CSTH07	1-1/2"	5.5
30CSTH08	2"	7.7
30CSTH09	2-1/2"	14.8
30CSTH10	3"	20.9
30CSTH11	4"	42.1

30CSSW

Carbon Steel Socket Weld Ball Valve - Three Piece - Full Port

1000 WOG

Locking Handle



30CSSW

30CSSW01	1/4"	0.8
30CSSW02	3/8"	0.8
30CSSW03	1/2"	1.1
30CSSW04	3/4"	1.5
30CSSW05	1"	2.2
30CSSW06	1-1/4"	3.5
30CSSW07	1-1/2"	5.5
30CSSW08	2"	7.7
30CSSW09	2-1/2"	14.8
30CSSW10	3"	20.9
30CSSW11	4"	42.1

30CSTHM

Carbon Steel Threaded Ball Valve - Three Piece - Full Port

1000 WOG

Locking Handle

ISO 5211 Mounting Pad



30CSTHM

30CSTH01M	1/4"	0.8
30CSTH02M	3/8"	0.8
30CSTH03M	1/2"	1.1
30CSTH04M	3/4"	1.5
30CSTH05M	1"	2.3
30CSTH06M	1-1/4"	3.6
30CSTH07M	1-1/2"	5.3
30CSTH08M	2"	7.7
30CSTH09M	2-1/2"	14.8
30CSTH10M	3"	21.6
30CSTH11M	4"	42.3

30CSSWM

Carbon Steel Socket Weld Ball Valve - Three Piece - Full Port

1000 WOG

Locking Handle

ISO 5211 Mounting Pad



30CSSWM

30CSSW01M	1/4"	0.8
30CSSW02M	3/8"	0.8
30CSSW03M	1/2"	1.1
30CSSW04M	3/4"	1.5
30CSSW05M	1"	2.3
30CSSW06M	1-1/4"	3.6
30CSSW07M	1-1/2"	5.3
30CSSW08M	2"	7.7
30CSSW09M	2-1/2"	14.8
30CSSW10M	3"	21.6
30CSSW11M	4"	42.3

Stainless Steel Valves



40SSTH

40SSTH

316 Stainless Steel Threaded Gate Valve - NRS

200 WOG

MATCO-NORCA MODEL NUMBER	SIZE	WEIGHT
40SSTH03	1/2"	1.0
40SSTH04	3/4"	1.2
40SSTH05	1"	1.5
40SSTH06	1-1/4"	2.2
40SSTH07	1-1/2"	3.1
40SSTH08	2"	5.0



50SSTH

50SSTH

316 Stainless Steel Threaded Globe Valve - Rising Stem

200 WOG

50SSTH03	1/2"	0.7
50SSTH04	3/4"	1.0
50SSTH05	1"	1.5
50SSTH06	1-1/4"	2.2
50SSTH07	1-1/2"	2.8
50SSTH08	2"	4.0



60SSTH

60SSTH

316 Stainless Steel Threaded Check Valve

200 WOG

60SSTH03	1/2"	0.7
60SSTH04	3/4"	1.0
60SSTH05	1"	1.5
60SSTH06	1-1/4"	2.2
60SSTH07	1-1/2"	3.4
60SSTH08	2"	4.7



70SSTH

70SSTH

316 Stainless Steel Threaded Y Strainer - 40 Mesh Screen

800 WOG

70SSTH03	1/2"	0.5
70SSTH04	3/4"	0.8
70SSTH05	1"	1.5
70SSTH06	1-1/4"	1.9
70SSTH07	1-1/2"	3.0
70SSTH08	2"	5.2

Cast & Ductile Iron Valves

Cast Iron & Ductile Iron Valves Butterfly Valves & Accessories



Butterfly Valves & Accessories

Cast Iron & Ductile Iron Valves Butterfly Valves & Accessories



Valves

Ductile Iron Gate Valves Resilient Wedge - Non-Rising Stem



200WW

200WW

Flanged Ductile Iron Gate Valve - Resilient Wedge - NRS

AWWA C509 200 CWP

Fusion Bonded Epoxy

HANDWHEEL OP. NUT

MATCO-NORCA MODEL NUMBER	SIZE	WEIGHT
200W08W	200W08NW 2"	31
200W10W	200W10NW 3"	53
200W11W	200W11NW 4"	77
200W13W	200W13NW 6"	135
200W14W	200W14NW 8"	209
200W15W	200W15NW 10"	333
200W16W	200W16NW 12"	462
14" and 16" Sizes Of This Product Are Available As:		
100W17	14"	750
100W18	16"	1026



200MW

200MW

Mechanical Joint Ductile Iron Gate Valve - Resilient Wedge - NRS

AWWA C509 200 CWP

Fusion Bonded Epoxy

OP. NUT OPEN RIGHT

MATCO-NORCA MODEL NUMBER	SIZE	WEIGHT
200M10W	200M10RW 3"	53
200M11W	200M11RW 4"	77
200M13W	200M13RW 6"	135
200M14W	200M14RW 8"	209
200M15W	200M15RW 10"	333
200M16W	200M16RW 12"	462
14" and 16" Sizes Of This Product Are Available As:		
100M17	14"	739
100M18	16"	942



200FJW

200FJW

Flanged X MJ Ductile Iron Gate Valve - Resilient Wedge - NRS - For IPS Pipe

AWWA C509 200 CWP

Fusion Bonded Epoxy

OP. NUT

MATCO-NORCA MODEL NUMBER	SIZE	WEIGHT
200FJ10W	3"	53
200FJ11W	4"	77
200FJ13W	6"	135
200FJ14W	8"	209
200FJ15W	10"	333
200FJ16W	12"	462

Cast Iron Gate Valves Resilient Wedge - Non-Rising Stem



10RW



10RS-N



10RT

MATCO-NORCA MODEL NUMBER	SIZE	WEIGHT
10RW Flanged Cast Iron Gate Valve - Resilient Wedge - NRS		
200 CWP 2" - 8" 150 CWP 10" - 12"		
3 Bosses - 1 Tapped & Plugged USC Approved		
Epoxy Coated		
HANDWHEEL	OP. NUT	
10RW08	10RW08N	2"
10RW09	-	2-1/2"
10RW10	10RW10N	3"
10RW11	10RW11N	4"
10RW12	10RW12N	5"
10RW13	10RW13N	6"
10RW14	10RW14N	8"
10RW15	-	10"
10RW16	-	12"
		25
		31
		42
		64
		97
		108
		191
		286
		393
10RS Threaded Cast Iron Gate Valve - Resilient Wedge - NRS		
200 CWP		
Epoxy Coated		
HANDWHEEL	OP. NUT	
10RS08	10RS08N	2"
10RS09	10RS09N	2-1/2"
10RS10	10RS10N	3"
10RS11	10RS11N	4"
10RS12	-	5"
10RS13	-	6"
		18
		20
		26
		44
		77
		95
10RT Ring-Tite Cast Iron Gate Valve - Resilient Wedge - NRS - For IPS Pipe		
200 CWP		
3 Bosses - 1 Tapped & Plugged		
Epoxy Coated		
OP. NUT		
10RT08		2"
10RT09		2-1/2"
10RT10		3"
10RT11		4"
10RT13		6"
10RT14		8"
		20
		22
		33
		46
		90
		154

Cast Iron Gate Valves

Ductile Iron Gate Valves Resilient Wedge - Non-Rising Stem

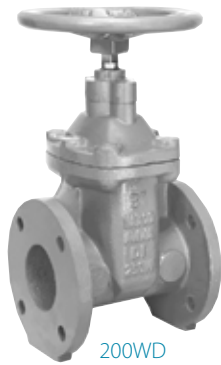

200WD

200WD

Flanged Ductile Iron Gate Valve - Resilient Wedge - NRS

AWWA C515 250 CWP

Fusion Bonded Epoxy

HANDWHEEL OP. NUT

MATCO-NORCA MODEL NUMBER	SIZE	WEIGHT
200WD08	2"	28
200WD09	2-1/2"	37
200WD10	3"	45
200WD11	4"	69
200WD13	6"	119
200WD14	8"	203
200WD15	10"	282
200WD16	12"	412
200WD18	16"	1,602

See 100W For 14" and 16" Sizes in Cast Iron On Page 46.



200MD

200MD

Mechanical Joint Ductile Iron Gate Valve - Resilient Wedge - NRS - Less Accessories

AWWA C515 250 CWP

Fusion Bonded Epoxy

OP. NUT

MATCO-NORCA MODEL NUMBER	SIZE	WEIGHT
200MD08	2"	28
200MD10	3"	44
200MD11	4"	56
200MD13	6"	98
200MD14	8"	160
200MD15	10"	245
200MD16	12"	311

See 100M For 14" and 16" Sizes in Cast Iron On Page 46.



200RTD

200RTD

Ring-Tite Ductile Iron Gate Valve - Resilient Wedge - NRS - For IPS Pipe

AWWA C515 250 CWP

Fusion Bonded Epoxy

OP. NUT

MATCO-NORCA MODEL NUMBER	SIZE	WEIGHT
200RTD08	2"	25
200RTD09	2-1/2"	31
200RTD10	3"	38
200RTD11	4"	54
200RTD13	6"	104
200RTD14	8"	171
200RTD15	10"	289
200RTD16	12"	447



200TVD

200TVD

Ductile Iron Tapping Gate Valve - Resilient Wedge - NRS - Less Accessories

AWWA C515 250 CWP

Fusion Bonded Epoxy

OP. NUT

MATCO-NORCA MODEL NUMBER	SIZE	WEIGHT
200TVD10	3"	48
200TVD11	4"	63
200TVD13	6"	108
200TVD14	8"	173
200TVD15	10"	262
200TVD16	12"	374

Cast Iron Gate Valves IBBM - Iron Body Bronze Mounted

Cast Iron Gate Valves

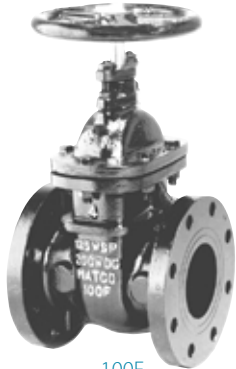

100F

MATCO-NORCA MODEL NUMBER	SIZE	WEIGHT
100F	Flanged Cast Iron Gate Valve - IBBM - NRS	
125 SWP 200 WOG		
3 Bosses MSS SP-70 WW-V-58-CL1		
Bituminous Coated		
HANDWHEEL		
100F08	2"	26
100F09	2-1/2"	35
100F10	3"	44
100F11	4"	77
100F12	5"	97
100F13	6"	128
100F14	8"	220
100F15	10"	315
100F16	12"	483
100F17	14"	807
100F18	16"	1077
100F19	18"	1301
OP. Nuts Available. See Page 59 for Part Numbers.		



105F

105F	Flanged Cast Iron Gate Valve - OS&Y - IBBM - Rising Stem	
125 SWP 200 WOG		
3 Bosses MSS SP-70 WW-V-58-CL1		
Bituminous Coated		
105F08	2"	29
105F09	2-1/2"	37
105F10	3"	50
105F11	4"	86
105F12	5"	115
105F13	6"	150
105F14	8"	249
105F15	10"	374
105F16	12"	524
105F17	14"	816
105F18	16"	1187
105F19	18"	1413
105F20	20"	2104
105F24	24"	3184



100S

100S	Threaded Cast Iron Gate Valve - IBBM - NRS	
125 SWP 200 WOG		
MSS SP-70 WW-V-58-CL1		
Bituminous Coated		
HANDWHEEL		
100S08	2"	23
100S09	2-1/2"	25
100S10	3"	34
100S11	4"	58
100S12	5"	77
100S13	6"	111

Cast Iron Gate & Globe Valves IBBM - Iron Body Bronze Mounted



105S

MATCO-NORCA MODEL NUMBER	SIZE	WEIGHT
105S	Threaded Cast Iron Gate Valve - OS&Y - IBBM - Rising Stem	
125 SWP 200 WOG		
MSS SP-70 WW-V-58-CL1		
Bituminous Coated		
105S08	2"	25
105S10	3"	40
105S11	4"	66



200F

MATCO-NORCA MODEL NUMBER	SIZE	WEIGHT
200F	Flanged Cast Iron Gate Valve - IBBM - NRS	
200 WOG - Not for Steam Service		
MSS SP-70		
Bituminous Coated		
HANDWHEEL		
200F09	2-1/2"	39
200F10	3"	47
200F11	4"	66
200F13	6"	139
200F14	8"	201
200F15	10"	295

OP. Nuts Available. See Page 59 for Part Numbers.



205F

MATCO-NORCA MODEL NUMBER	SIZE	WEIGHT
205F	Flanged Cast Iron Gate Valve - OS&Y - IBBM - Rising Stem	
200 WOG - Not for Steam Service		
MSS SP-70		
Bituminous Coated		
205F10	3"	51
205F11	4"	75
205F13	6"	141
205F14	8"	223
205F15	10"	322



150F

MATCO-NORCA MODEL NUMBER	SIZE	WEIGHT
150F	Flanged Cast Iron Globe Valve - OS&Y - IBBM - Rising Stem	
125 SWP 200 CWP		
MSS-SP-85		
Bituminous Coated		
150F08	2"	38
150F09	2-1/2"	49
150F10	3"	60
150F11	4"	99
150F13	6"	187
150F14	8"	315

Cast Iron & Ductile Iron Gate Valves Resilient Seat



MATCO-NORCA MODEL NUMBER	SIZE	WEIGHT
105W	Flanged Cast Iron Gate Valve - OS&Y - Resilient Wedge - Rising Stem	
	AWWA C509 3" - 12" 200 CWP 14" - 16" 150 CWP	
	3 Bosses - 1 Tapped & Plugged	
	Fusion Bonded Epoxy	
105W10	3"	64
105W11	4"	93
105W13	6"	157
105W14	8"	269
105W15	10"	436
105W16	12"	597
105W17	14"	827
105W18	16"	1135



105U	Flanged Cast Iron Gate Valve - OS&Y - Resilient Wedge - Rising Stem	
	175 CWP	
	3 Bosses - 1 Tapped & Plugged N.Y.C. APPROVED USC Approved	
	Fusion Bonded Epoxy	
105U10	3"	66
105U11	4"	97
105U13	6"	164
105U14	8"	283
105U15	10"	456

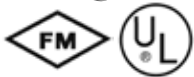

205U	Flanged Ductile Iron Gate Valve - OS&Y - Resilient Wedge - Rising Stem	
	AWWA C515 300 CWP Max. Temperature 160° F	
	4 Bosses - 1 Tapped & Plugged	
	Fusion Bonded Epoxy Coating - AWWA C550	
205U10	3"	69
205U11	4"	104
205U13	6"	172
205U14	8"	243
205U15	10"	441



305U	Flanged Ductile Iron Gate Valve - OS&Y - Resilient Wedge - Rising Stem	
	AWWA C515 300 CWP Max. Temperature 230° F	
	4 Bosses - 1 Tapped & Plugged	
	Fusion Bonded Epoxy Coating - AWWA C550	
305U09	2-1/2"	38
305U10	3"	51
305U11	4"	70
305U13	6"	117
305U14	8"	201
305U15	10"	297
305U16	12"	437

Cast Iron Swing Check Valves IBBM & Resilient Seat



115F

MATCO-NORCA MODEL NUMBER	SIZE	WEIGHT
115F	Flanged Cast Iron Swing Check Valve - IBBM	
125 SWP 200 WOG		
One Boss MSS-SP-71 Bituminous Coated		
115F08	2"	20
115F09	2-1/2"	31
115F10	3"	42
115F11	4"	69
115F12	5"	80
115F13	6"	115
115F14	8"	231
115F15	10"	357
115F16	12"	498



115S

115S	Threaded Cast Iron Swing Check Valve - IBBM	
125 SWP 200 WOG		
MSS-SP-71 Bituminous Coated		
115S08	2"	14
115S09	2-1/2"	18
115S10	3"	27
115S11	4"	53
115S12	5"	79



120F

120F	Flanged Cast Iron Swing Check Valve - Resilient Seat	
200 CWP		
One Boss MSS-SP-71 Epoxy Coated		
120F08	2"	20
120F09	2-1/2"	31
120F10	3"	41
120F11	4"	69
120F12	5"	79
120F13	6"	115
120F14	8"	230
120F15	10"	356
120F16	12"	497



120S

120S	Threaded Cast Iron Swing Check Valve - Resilient Seat	
200 CWP		
MSS-SP-71 Epoxy Coated		
120S08	2"	14
120S09	2-1/2"	18
120S10	3"	27
120S11	4"	53
120S13	6"	99

Cast Iron Swing Check Valves Resilient Seat

Cast Iron Check Valves



120W

120W

**MATCO-NORCA
MODEL NUMBER**

SIZE

WEIGHT

Flanged Cast Iron Swing Check Valve - Resilient Seat

AWWA C508 200 CWP

One Boss Fusion Bonded Epoxy

120W10	3"	56
120W11	4"	75
120W13	6"	144
120W14	8"	275
120W15	10"	435
120W16	12"	594

120WC

Flanged Cast Iron Check Valve - Resilient Seat - Outside Lever And Weight

AWWA C508 3" - 12" - 200 CWP 14" - 16" - 150 CWP

One Boss Fusion Bonded Epoxy



120WC



P120WSK

120WC10	3"	57
120WC11	4"	84
120WC13	6"	156
120WC14	8"	294
120WC15	10"	466
120WC16	12"	627
120WC17	14"	873
120WC18	16"	1025

P120WSK Spring Kit Available For 120WC.

P120WLW Replacement Lever & Weight Available for 120WC.



120U

Flanged Cast Iron Swing Check Valve - Resilient Seat

175 CWP

**One Boss N.Y.C. Approved
Fusion Bonded Epoxy**



120U

MODEL NUMBER	SIZE	DRAIN ON BOTTOM	WEIGHT
120U09	2-1/2"	1/2"	44
120U10	3"	1/2"	51
120U11	4"	1/2"	79
120U13	6"	3/4"	152
120U14	8"	1"	312
120U15	10"	1"	462
120U16	12"	1"	662

Wafer Style Check Valves



CVC

MATCO-NORCA MODEL NUMBER	SIZE	WEIGHT
CVC	Wafer Check Valve - Double Bronze Disc - BUNA-N Seat	
	Class 125 300 WOG	
	Ductile Iron Body - SS Springs & Shaft	
CVC - 2	2"	4
CVC - 2.5	2-1/2"	5
CVC - 3	3"	8
CVC - 4	4"	13
CVC - 5	5"	16
CVC - 6	6"	20
CVC - 8	8"	38
CVC - 10	10"	57
CVC - 12	12"	92
CVC - 14	14"	121
CVC - 16	16"	165



SC

MATCO-NORCA MODEL NUMBER	SIZE	WEIGHT
SC	Silent Wafer Check Valve - Poppet Style - Bronze Disc And Seat	
	Class 125 200 WOG	
	Cast Iron Body - SS Spring	
SC-2	2"	7
SC-2.5	2-1/2"	9
SC-3	3"	15
SC-4	4"	25
SC-5	5"	32
SC-6	6"	56
SC-8	8"	100
SC-10	10"	140
SC-12	12"	340

Cast Iron Y Strainers

Cast Iron Y Strainers



140F

MATCO-NORCA MODEL NUMBER	SIZE	WEIGHT
140F	Flanged Cast Iron Y Strainer	
	125 SWP 200 WOG	
	Bituminous Coated	
140F08	2"	20
140F09	2-1/2"	31
140F10	3"	42
140F11	4"	73
140F12	5"	107
140F13	6"	121
140F14	8"	198
140F15	10"	372
140F16	12"	539



140S

MATCO-NORCA MODEL NUMBER	SIZE	WEIGHT
140S	Threaded Cast Iron Y Strainer	
	250 SWP	
	Bituminous Coated	
140S01	1/4"	1
140S02	3/8"	1
140S03	1/2"	1
140S04	3/4"	2
140S05	1"	3
140S06	1-1/4"	5
140S07	1-1/2"	7
140S08	2"	12
140S09	2-1/2"	27
140S10	3"	38

Cast Iron Flanges: Companion, Reducing, Blind, PVC Van Stone Flanges

Cast Iron & PVC Flanges

**MATCO-NORCA
MODEL NUMBER**

CICF

Cast Iron Companion Flange



CICFB



CICFG

Black	Galv.	Flange x O.D.	# Of Holes	Weight
CICFB07	CICFG07	1-1/2" x 5"	4	3
CICFB08	CICFG08	2" x 6"	4	4
CICFB09	CICFG09	2-1/2" x 7"	4	6
CICFB10	CICFG10	3" x 7-1/2"	4	8
CICFB11	CICFG11	4" x 9"	8	12
CICFB12	CICFG12	5" x 10"	8	14
CICFB13	CICFG13	6" x 11"	8	17
CICFB14	CICFG14	8" x 13-1/2"	8	26
CICFB15	CICFG15	10" x 16"	12	38
CICFB16	CICFG16	12" x 19"	12	57

**MATCO-NORCA
MODEL NUMBER**

CIRF

Cast Iron Reducing Flange



CIRFB



CIRFG

Black	Galv.	Flange x IPS	IPS x O.D.	# Of Holes	Weight
CIRFB32	CIRFG32	3" x 2"	2" x 7-1/2"	4	9
CIRFB42	CIRFG42	4" x 2"	2" x 9"	8	14
CIRFB43	CIRFG43	4" x 3"	3" x 9"	8	13
CIRFB54	CIRFG54	5" x 4"	4" x 10"	8	16
CIRFB62	CIRFG62	6" x 2"	2" x 11"	8	26
CIRFB63	CIRFG63	6" x 3"	3" x 11"	8	23
CIRFB64	CIRFG64	6" x 4"	4" x 11"	8	21
CIRFB65	CIRFG65	6" x 5"	5" x 11"	8	19
CIRFB82	CIRFG82	8" x 2"	2" x 13-1/2"	8	44
CIRFB83	CIRFG83	8" x 3"	3" x 13-1/2"	8	40
CIRFB84	CIRFG84	8" x 4"	4" x 13-1/2"	8	37
CIRFB85	CIRFG85	8" x 5"	5" x 13-1/2"	8	34
CIRFB86	CIRFG86	8" x 6"	6" x 13-1/2"	8	31

CIBF

Cast Iron Blind Flange



CIBF

Black	Nominal Size	Flange x O.D.	# Of Holes	Weight
CIBFB08	2"	2" x 6"	4	5
CIBFB09	2-1/2"	2-1/2" x 7"	4	7
CIBFB10	3"	3" x 7-1/2"	4	9
CIBFB11	4"	4" x 9"	8	16
CIBFB13	6"	6" x 11"	8	25
CIBFB14	8"	8" x 13-1/2"	8	42
CIBFB15	10"	10" x 16"	12	65
CIBFB16	12"	12" x 19"	12	85

PVCF

**PVC Van Stone Flange - (Sch 80)
Socket (Swivel)**



PVCF

		# Of Holes	Weight
PVCF08	2"	4	1
PVCF10	3"	4	2
PVCF11	4"	8	3
PVCF12	5"	8	4
PVCF13	6"	8	4
PVCF14	8"	8	6
PVCF15	10"	12	11
PVCF16	12"	12	20

Accessories: Gaskets, Bolts & Bolt & Gasket Sets

**MATCO-NORCA
MODEL NUMBER**

SIZE

GSNA/GNA 150# Non-Asbestos Ring Bolt Pack - 1/16"

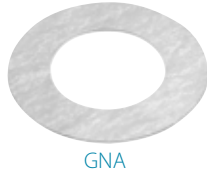

Pack	Gasket Only	
GSNAG2	GNA2	2"
GSNAG2.5	GNA2.5	2-1/2"
GSNAG3	GNA3	3"
GSNAG4	GNA4	4"
GSNAG5	GNA5	5"
GSNAG6	GNA6	6"
GSNAG8	GNA8	8"
GSNAG10	GNA10	10"
GSNAG12	GNA12	12"
GSNAG14	GNA14	14"
GSNAG16	GNA16	16"

**MATCO-NORCA
MODEL NUMBER**

SIZE

GSNAFF/GFFNA 150# Non-Asbestos Full Face Bolt Pack - 1/16"



Pack	Gasket Only	
GSNAFFG2	GFFNA2	2"
GSNAFFG2.5	GFFNA2.5	2-1/2"
GSNAFFG3	GFFNA3	3"
GSNAFFG4	GFFNA4	4"
GSNAFFG5	GFFNA5	5"
GSNAFFG6	GFFNA6	6"
GSNAFFG8	GFFNA8	8"

GSFF/GFF 150# Full Face Red Rubber Bolt Pack - 1/8"

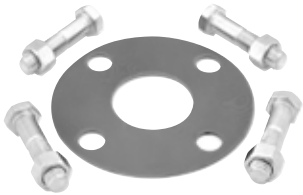

Pack	Gasket Only	
GSFFG2	GFF2	2"
GSFFG2.5	GFF2.5	2-1/2"
GSFFG3	GFF3	3"
GSFFG4	GFF4	4"
GSFFG5	GFF5	5"
GSFFG6	GFF6	6"
GSFFG8	GFF8	8"
GSFFG10	GFF10	10"
GSFFG12	GFF12	12"
GSFFG14	GFF14	14"
GSFFG16	GFF16	16"

GSNAX/GNAX 300# Non-Asbestos Ring Bolt Pack - 1/16"

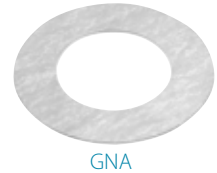
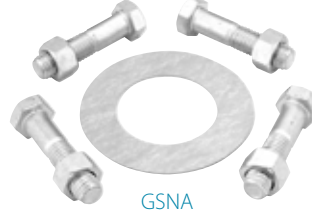

Pack	Gasket Only	
GSNAXG2	GNAX2	2"
GSNAXG2.5	GNAX2.5	2-1/2"
GSNAXG3	GNAX3	3"
GSNAXG4	GNAX4	4"
GSNAXG5	GNAX5	5"
GSNAXG6	GNAX6	6"
GSNAXG8	GNAX8	8"

SBG Plated Stud Bolt, Nut And Washer Set

For Wafer Butterfly Valves

	Fits Sizes	Quantity and Bolt Size
SBG2	2" & 2-1/2"	(4) 5/8" x 6"
SBG3	3"	(4) 5/8" x 7"
SBG4	4"	(8) 5/8" x 7"
SBG6	5", 6" & 8"	(8) 3/4" x 7"
SBG10	10" & 12"	(12) 7/8" x 8"
SBG14	14"	(12) 1" x 8"
SBG16	16"	(16) 1" x 10"



Mechanical Joint Accessory Kits

T-Wrench For Cast & Ductile Valves



100MJ

MATCO-NORCA MODEL NUMBER	SIZE	WEIGHT
100MJ	MJ Accessory Kit - Fits Ductile Iron & C-900 Pipe Includes - STD T-Head Bolts, MJ Gasket & D.I. Gland	
100MJ2	2"	5
100MJ3	3"	7
100MJ4	4"	8
100MJ6	6"	12
100MJ8	8"	15
100MJ10	10"	20
100MJ12	12"	25
100MJ14	14"	25
100MJ16	16"	25



100MJX

MATCO-NORCA MODEL NUMBER	SIZE	WEIGHT
100MJX	MJ Transition Accessory Kit - Fits (IPS) PVC & Steel Pipe Includes - STD T-Head Bolts, Transition Gasket & D.I. Gland	
100MJX2	2"	5
100MJX3	3"	7
100MJX4	4"	8
100MJX6	6"	12
100MJX8	8"	15
100MJX10	10"	20
100MJX12	12"	25



EMKL

MATCO-NORCA MODEL NUMBER	SIZE	WEIGHT
EMKL	T-Wrench For 2" Operating Nut	
EMKL36	36"	
EMKL60	60"	

Wheel Handles & Operating Nuts For Iron Gate Valves

WH Wheel Handles For Iron Gate Valves



P-2WH



P-WH-U

MATCO-NORCA MODEL #	SIZE	FITS MODEL #	SIZE	FITS MODEL #
P-WH-A	2", 2-1/2"	10RS/W/T		
P-WH-B	3"	10RS/W/T	2", 2-1/2"	100F/S
P-WH-C	4"	10RS/W/T	3"	100F/S
P-WH-D	4"	100F/S		
P-WH-E	5", 6"	10RS/W/T	5", 6"	100F/S
P-WH-F	8"	10RS/W/T	8"	100F/S
P-WH-G	10"	10RS/W/T	10"	100F
P-WH-H	12"	10RS/W/T	12"	100F
P-WH-U3	2-1/2, 3"	105U		
P-WH-U4	4"	105U		
P-WH-U6	6"	105U		
P-WH-U8	8"	105U		
P-WH-U10	10"	105U		
P-WH-U12	12"	105U		
P105FA	2"	105F/S	2", 2-1/2"	12RW
P105FB	2-1/2"	105F/S	3"	12RW
P105FC	3"	105F/S/W	4"	12RW
P105FD	4"	105F/S/W	5", 6"	12RW
P105FE	5"	105F/S		
P105FG	6"	105F/S/W		
P105FH	8"	105F/S/W		
P105FI	10"	105F/S/W		
P105FJ	12"	105F/S/W		
P-2DWH8	2"	200WD/WW/MW	2"	100RTW
P-2DWH9	2-1/2"	200WD/WW/MW	2-1/2"	100RTW
P-2DWH10	3"	200WD/WW/MW/FJW	3"	100RTW
P-2DWH11	4"	200WD/WW/MW/FJW	4"	100RTW
P-2DWH13	6"	200WD/WW/MW/FJW	6"	100RTW
P-2DWH14	8"	200WD/WW/MW/FJW	8"	100RTW
P-2DWH15	10"	200WD/WW/MW/FJW	10"	100RTW
P-2DWH16	12"	200WD/WW/MW/FJW	12"	100RTW
Old Style Handwheels				
P-2WH10	3"	200W/M/FJ	3"	100RT
P-2WH11	4"	200W/M/FJ	4"	100RT
P-2WH13	6"	200W/M/FJ	6"	100RT
P-2WH14	8"	200W/M/FJ	8"	100RT
P-2WH15	10"	200W/M/FJ	10"	100RT

OP 2" Operating Nut For NRS Iron Gate Valves



P-100NB



P-100NL

MATCO-NORCA MODEL #	SIZE	FITS MODEL #	SIZE	FITS MODEL #
P-100NA	2", 2-1/2"	10RS/W/T		
P-100NB	3"	10RS/W/T	2", 2-1/2"	100F/S
P-100NC	4"	10RS/W/T	3"	100F/S
		200F		
P-100ND	4"	100F/S		
		200F		
P-100NE	5", 6"	10RS/W/T	5", 6"	100F/S
		200F		
P-100NF	8"	10RS/W/T	8"	100F/S
		200F		
P-100NG	10"	10RW	10"	100F
P-100NH	12"	10RW	12"	100F
P-100NL	14"	100W/M/F		
P-100NM	16"	100F		
P-100NO	18"	100F		
P-100NP	16"	100W/M		

OP 2" Operating Nut For NRS Iron Gate Valves



P-200DNC

P-200DNC	2" - 4"
P-200DND	6" - 8"
P-200DNF	10"
P-200DNG	12"

Butterfly Valve Part # Breakdown

Butterfly Valve Part # Breakdown

B5-RLO4

B5 **RLO** **4** **-**

Choose Series	
B1	
B5	
B6	
B7	

Select Style	
RLO	Wafer Style, Lever Operated
RWG	Wafer Style, Gear Operated
LGL	Lug Style, Lever Operated
LGG	Lug Style, Gear Operated

Part#	Size
2	2"
2.5	2-1/2"
3	3"
4	4"
5	5"
6	6"
8	8"
10	10"
12	12"
Through 36"	

Disc & Liner	Example
-	Nickel Plated Ductile Iron Disc - BUNA-N Liner
AB	Aluminum-Bronze Disc - BUNA-N Liner
ABE	Aluminum-Bronze Disc - EPDM Liner
S	316 Stainless Steel Disc - BUNA-N Liner
SE	316 Stainless Steel Disc - EPDM Liner

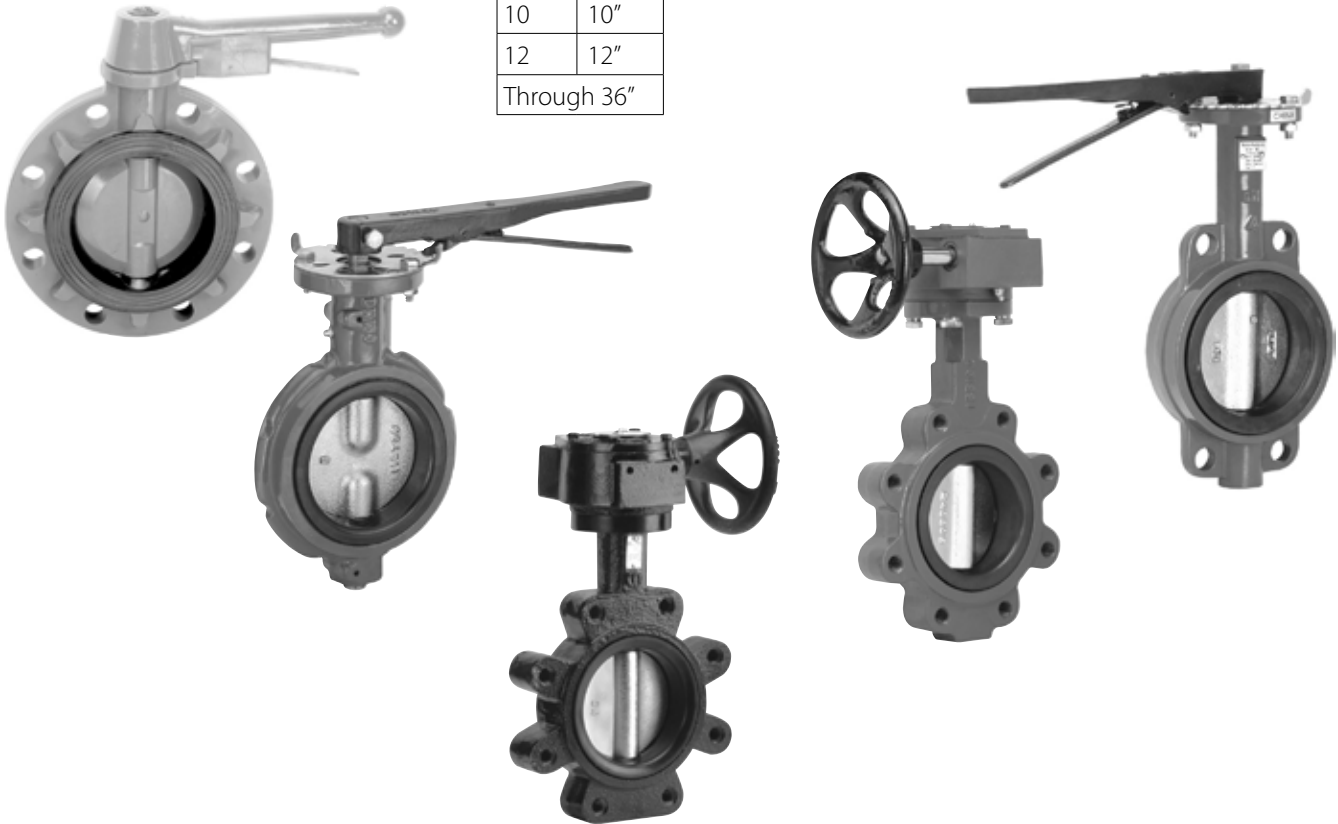

B1 PVC Butterfly Valves & Parts

	MATCO-NORCA MODEL NUMBER	SIZE	WEIGHT
B1	PVC Wafer Butterfly Valve - 200 PSI		
	B1-RLO 10 Position Lock Lever Operated		
	B1-RLO2	2"	4
	B1-RLO2.5	2-1/2"	4
	B1-RLO3	3"	7
	B1-RLO4	4"	8
	B1-RLO6	6"	11
	B1-RWG Gear Operated		
	B1-RWG8	8"	28
	B1-RWG10	10"	36
	B1-RWG12	12"	65
	Valves Only Available with Stainless Steel Stem, EPDM Liner, Polypropylene Disc.		

B1 Butterfly Valves & Parts

B1 Parts

B1L	Lever Handle For B1 Butterfly Valve	
	Replacement Handles For B1 Butterfly Valve	
	Round End - Old Style	
	B1L6	6"
	Square End - New Style	
	B1L10	3"
	B1L11	4"
	B1L13	6"

B5 Butterfly Valves

Gear or 10 Position Lock Lever Operated

B5 Butterfly Valves

MATCO-NORCA MODEL NUMBER **SIZE** **WEIGHT**

B5-RLO **Ductile Iron Wafer Butterfly Valve - 200 PSI**



B5-RLO

B5-RLO2	2"	9
B5-RLO2.5	2-1/2"	11
B5-RLO3	3"	12
B5-RLO4	4"	15
B5-RLO5	5"	19
B5-RLO6	6"	22
B5-RLO8	8"	39
B5-RLO10	10"	55
B5-RLO12	12"	75

MATCO-NORCA MODEL NUMBER **SIZE** **WEIGHT**

B5-LGL **Ductile Iron Lug Butterfly Valve - 200 PSI**



B5-LGL

B5-LGL2	2"	10
B5-LGL2.5	2-1/2"	12
B5-LGL3	3"	13
B5-LGL4	4"	20
B5-LGL5	5"	24
B5-LGL6	6"	26
B5-LGL8	8"	45
B5-LGL10	10"	64
B5-LGL12	12"	86

B5-RWG **Ductile Iron Wafer Butterfly Valve**



B5-RWG

2" - 12" Valves Are Rated 200 PSI
14" - 36" Valves Are Rated 150 PSI

B5-RWG2	2"	18
B5-RWG2.5	2-1/2"	20
B5-RWG3	3"	21
B5-RWG4	4"	24
B5-RWG5	5"	29
B5-RWG6	6"	31
B5-RWG8	8"	59
B5-RWG10	10"	75
B5-RWG12	12"	102
B5-RWG14	14"	125
B5-RWG16	16"	207
B5-RWG18	18"	251
B5-RWG20	20"	349
B5-RWG24	24"	448
B5-RWG30	30"	1155
B5-RWG36	36"	1859

B5-LGG **Ductile Iron Lug Butterfly Valve**



B5-LGG

2" - 12" Valves Are Rated 200 PSI
14" - 36" Valves Are Rated 150 PSI

B5-LGG2	2"	21
B5-LGG2.5	2-1/2"	21
B5-LGG3	3"	24
B5-LGG4	4"	29
B5-LGG5	5"	33
B5-LGG6	6"	35
B5-LGG8	8"	64
B5-LGG10	10"	83
B5-LGG12	12"	113
B5-LGG14	14"	149
B5-LGG16	16"	244
B5-LGG18	18"	282
B5-LGG20	20"	374
B5-LGG24	24"	662
B5-LGG30	30"	1250
B5-LGG36	36"	2050

Available with Nickel Plated Ductile Disc;
Available with BUNA-N Liner; See Butterfly Valve Part # Breakdown Page 54.

B5 Butterfly Valve Parts & Accessories

MATCO-NORCA MODEL NUMBER SIZE

B5L Lever Handle For B5 Butterfly Valve



B5L3	2" - 3"
B5L4	4"
B5L6	6"
B5L8	8"
B5L10	10"
B5L12	12"

B5IND Index Plate For B5 Butterfly Valve



Chrome Plated

B5IND23	2" - 3"
B5IND810	8" - 10"
B5IND12	12"

Stainless Steel Plated

B5IND3S	3"
B5IND4S	4"
B5IND6S	6"

B5GRNUT Gear Nut For B5 Butterfly Valve



B5GRNUT6	2" - 6"
B5GRNUT12	8" - 12"
B5GRNUT14	14"
B5GRNUT16	16"
B5GRNUT18	18"
B5GRNUT20	20"
B5GRNUT24	24"

MATCO-NORCA MODEL NUMBER SIZE

B5G Gear For B5 Butterfly Valve



With Handwheel & Pin

B5G23	2" - 3"	B5G14	14"
B5G4	4"	B5G16	16"
B5G56	5" - 6"	B5G18	18"
B5G8	8"	B5G24	24"
B5G10	10"		
B5G12	12"		
B5G12R	12" Rounded		

B5WH Hand Wheel For B5 Butterfly Valve



B5-WH2	2" - 6"
B5-WH8	8" - 12"
B5-WH16	16"
B5-WH18	18"
B5-WH30	30"
B5-WH36	36"

B5X Stem Extension For B5 Butterfly Valve



	Fits Valve Size	Length of Extension
B5-X** A	2" - 3"	24"
B5-X** B	4"	36"
B5-X** C	5" - 6"	48"
B5-X** D	8"	60"
B5-X** E	10"	72"
B5-X** F	12"	
B5-X** G	14"	
B5-X** H	16"	
B5-X** I	18"	
B5-X** J	20"	
B5-X** K	24"	

Example: B5-X24-A=

24" Extension For
2" - 3" Butterfly Valve

**Place Holder For Length of Extension.
Flat & Round Extensions Also Available.

B5LCH Latch Nut For B5 Butterfly Valve



B5-LCH-3	2" - 3"
B5-LCH-4	4"
B5-LCH-6	6"

B5 Butterfly Valve Parts

B6 Butterfly Valves Gear or 10 Position Lock Lever Operated

MATCO-NORCA MODEL NUMBER SIZE WEIGHT B6-RLO Cast Iron Wafer Butterfly Valve - 200 PSI



B6-RLO

MATCO-NORCA MODEL NUMBER	SIZE	WEIGHT
B6-RLO2	2"	7
B6-RLO2.5	2-1/2"	9
B6-RLO3	3"	10
B6-RLO4	4"	13
B6-RLO5	5"	17
B6-RLO6	6"	19
B6-RLO8	8"	31
B6-RLO10	10"	45
B6-RLO12	12"	74

MATCO-NORCA MODEL NUMBER SIZE WEIGHT B6-LGL Cast Iron Lug Butterfly Valve - 200 PSI



B6-LGL

MATCO-NORCA MODEL NUMBER	SIZE	WEIGHT
B6-LGL2	2"	10
B6-LGL2.5	2-1/2"	11
B6-LGL3	3"	13
B6-LGL4	4"	22
B6-LGL5	5"	26
B6-LGL6	6"	33
B6-LGL8	8"	42
B6-LGL10	10"	63
B6-LGL12	12"	92

MATCO-NORCA MODEL NUMBER SIZE WEIGHT B6-RWG Cast Iron Wafer Butterfly Valve - 200 PSI



B6-RWG

MATCO-NORCA MODEL NUMBER	SIZE	WEIGHT
B6-RWG2	2"	17
B6-RWG2.5	2-1/2"	18
B6-RWG3	3"	19
B6-RWG4	4"	22
B6-RWG5	5"	27
B6-RWG6	6"	29
B6-RWG8	8"	55
B6-RWG10	10"	68
B6-RWG12	12"	101

MATCO-NORCA MODEL NUMBER SIZE WEIGHT B6-LGG Cast Iron Lug Butterfly Valve - 200 PSI



B6-LGG

MATCO-NORCA MODEL NUMBER	SIZE	WEIGHT
B6-LGG2	2"	20
B6-LGG2.5	2-1/2"	21
B6-LGG3	3"	22
B6-LGG4	4"	31
B6-LGG5	5"	36
B6-LGG6	6"	43
B6-LGG8	8"	63
B6-LGG10	10"	86
B6-LGG12	12"	118

Valves Only Come With Stainless Steel Stem, BUNA-N Seat, Ductile Disc.

B6 Butterfly Valve Parts

B7 Butterfly Valve

**MATCO-NORCA
MODEL NUMBER**

SIZE

B6L

Lever Handle For B6 Butterfly Valve



B6L3	2" - 3"
B6L4	4"
B6L6	6"
B6L8	8"
B6L10	10"
B6L12	12"

**MATCO-NORCA
MODEL NUMBER**

SIZE

B6G

Gear For B6 Butterfly Valve



With Handwheel & Pin

B6G23	2" - 3"
B6G4	4"
B6G56	5 - 6"
B6G8	8"
B6G10	10"
B6G12	12"

B6IND

Index Plate For B6 Butterfly Valve



B6IND26	2" - 6"
B6IND812	8" - 12"

B6 Butterfly Valve Parts
& B7 Butterfly Valve

B7 Butterfly Valve

**MATCO-NORCA
MODEL NUMBER**

SIZE

WEIGHT

B7

Cast Iron Wafer Butterfly Valve - Double Stem - 200 PSI - Short Neck



B7-RLO

B7-RLO2	2"	8
B7-RLO2.5	2-1/2"	10
B7-RLO3	3"	11
B7-RLO4	4"	15
B7-RLO5	5"	20
B7-RLO6	6"	22
B7-RLO8	8"	36
B7-RLO10	10"	51
B7-RLO12	12"	71

Available With Stainless Steel Stem, BUNA-N Liner, Ductile Disc or Aluminum Bronze Disc.

Terms & Conditions Of Sale

Acceptance

Orders, whether verbal or written, are subject to acceptance by Matco-Norca, Inc. Hereinafter referred to as the seller at its Brewster, N.Y. office. No terms or conditions of buyers order contrary to seller's terms and conditions shall be binding upon seller unless specifically agreed upon by seller in writing. Sellers acceptance of orders shall occur by written acknowledgement or tender of delivery of goods and or services the subject hereof (goods), which ever occurs first.

Prices And Sales Policy

Until written confirmation of this contract has been received by buyer, all prices are subject to change without prior notice. We reserve the right to adjust orders to standard package quantities unless otherwise stated on buyers purchase order. We reserve the right to make product improvement without notice. If seller determines buyer's credit is unsatisfactory or there is reasonable doubt concerning buyer's ability to pay, payment in advance may be required or buyer shall provide security for such payment in an amount and form acceptable to seller. Unless otherwise specified by seller, terms are 2% 10 days/net 30 days.

Cash discounts apply to the value of goods at the net invoiced value before transportation charges, taxes and additional duties. Unearned cash discounts will be charged back as an unpaid balance to the buyers account. Any past due amount is subject to a finance charge of 1-1/2% per month (18% per year) on the total past due balance in accordance with the Truth-in-lending Act in Title 1 of the Federal Consumer Protection Act effective July 1, 1969.

Taxes

All prices are exclusive of taxes and excises. Sales, use and other taxes, by whomsoever levied, are to be paid by the buyer and unless invoiced, are to be paid by buyer direct to the appropriate governmental agency. Buyers are required to furnish seller with a copy of their tax exemption of resale certificate, otherwise applicable state sales taxes will be charged.

Delivery And Shipment Of Materials

All goods are sold F.O.B. sellers warehouse. Delivery of material to a common carrier shall constitute delivery thereof to buyer and risk of loss shall pass to buyer at such time. Claims for damage to or loss of material in transit shall be filed by buyer direct with carrier. Buyer assumes all risks and liability for the results obtained by the use of material delivered hereunder. No claim of any kind, whether as to material delivered or for nondelivery or late delivery of material and whether based on negligence or otherwise, shall be greater in amount than the purchase price of the material in respect to which such claim is made. In no event shall seller be liable for indirect or consequential damages or for anticipated profits or loss of use of equipment.

Returns And Cancellations

Permission in writing and return authorization must be obtained from seller before any goods are returned. All returns must be prepaid, no collect shipments will be accepted. All returns made for reasons other than defects are subject to a restocking charge. Discontinued goods are not returnable.

Cancellation of orders may be made only with the sellers written consent and shall be subject to cancellation charges.

Governing law

The entering into, construction, interpretation, performance and discharge of the terms set forth herewith shall be governed in accordance with the laws of the State of New York.

Limited One Year Warranty

Seller warrants the material to be free of defects in material and workmanship, under normal use, proper maintenance and proper operation, for a period of one year from date of delivery to a common carrier for shipment to buyer or his designated agent. The obligation of the seller is limited to (1) repair of the material, or (2) replacement of any component or components proven defective in material or workmanship, or (3) refund of the purchase price. Seller shall have no liability for the cost of removal or reinstallation with respect to any replaced or repaired product. The election of said remedies shall be determined by seller in its sole discretion and shall be considered final disposition.

All implied warranties, including the implied warranties of merchantability and fitness for a particular purpose, are hereby disclaimed and excluded. This warranty is in lieu of all other warranties, guarantees, agreements and similar obligations or seller, in no event shall seller be liable for consequential or incidental damages.

Claims

No later than ten (10) days from receipt of material buyer will report, in writing, all claims for any damage, defects or shortages. All claims, including for alleged damaged or defective material, shortage negligence or any other cause whatsoever ("defective performance"), shall deemed waived unless made in writing within the ten (10) day period. However, any defective performance not discoverable within said ten (10) day period (including that discoverable only in processing or in further manufacturing) shall be deemed waived unless made in writing and received by seller in writing within ninety (90) days after receipt or within ten (10) days after buyer learns of the alleged defect, whichever occurs first. Seller's liability shall in no event exceed the purchase price of the material in respect to which the claim is made, or at the election of seller at its sole discretion, and to repair or replacement of such material. Seller shall not be liable for, and buyer assumes all responsibility for, all personal injury and property damage resulting from handling, possession, use or resale of the material by buyer. In no event shall seller be liable for incidental or consequential damages, whether buyer's claim is in contract, negligence, or otherwise. If claim is made, buyer shall permit seller at seller's option to re-inspect the material at buyer's plant or if seller so directs, buyer shall return the material at buyer's expense to seller's facility for re-inspection. No material may be returned to seller without prior written permission from seller.

Force Majeure

Anything in this agreement to the contrary notwithstanding, it is expressly agreed that seller shall not be liable for any damages resulting from, and buyer shall not have the right to cancel this order because of any delays caused in whole or in part by fires, floods, windstorms, tornadoes, wars, riots, insurrections, strikes, lockouts sit-downs, slow-downs, or other labor trouble, causing cessation or interruption of operation or by accident, material shortages, labor or fuel shortages, or inability to procure labor or materials, either on the part of the seller, or because any plant, plants or any portion thereof belonging to seller have been commandeered by the legally constituted public authority, or because of any priorities or preferences established for the manufacture, assembly or allotment of materials by order, decree, or to otherwise of the united states, or by any department, bureau, commission, committee, agent or administrator of any legally constituted public authority in any plant of seller, or any of its suppliers, or resulting from any other cause beyond the control of seller.

Quick Find Index

ITEM NAME PAGE NUMBER

10	
10RS	47
10RT	47
10RW	47
15SSTH	39
20	
20CSFLD	39
20SSFLD	39
20SSTHM	40
25CSTHM	40
25LF	33
25SSTHM	40
26LF	33
29LF	32
30	
30CSSW	42
30CSSWM	42
30CSTH	42
30CSTHM	42
30SSSW	41
30SSSWM	41
30SSTH	41
30SSTHM	41
40	
40SSTH	43
50	
50SSTH	43
58	10, 11
59	10
59DB	35
60	
60SSTH	43
70	
70SSTH	43
100	
100F	49
100M	46
100MJ	58
100MJX	58
100S	49
100W	46
105F	49
105S	50
105U	51
105W	51
115F	52
115S	52
120F	52
120S	52
120U	53
120W	53
120WC	53

ITEM NAME PAGE NUMBER

140F	55
140S	55
145	17
146	17
150F	50
200	
200AL	9
200F	50
200FJW	46
200L	9
200LF	9
200MD	48
200MW	46
200RTD	48
200TVD	48
200WD	48
200WW	46
201	23
201A	23
201CMLF	23
202CMLF	23
202LF	23
203	28
204	22
205	22
205CM	22
205F	22, 50
205U	51
205WH	31
206	28
206H	28
206HLK	28
206VB	28
207	26
209	29
209PX	29
212	29
212PX	29
240H	9
240T	9
300	
300BV	6
305U	51
400	
434LF	34
500	
501	15
503	14
511	15
512	15
513	15
514	14
517	14
519	16
519TP	16

ITEM NAME PAGE NUMBER

521	18
521N	18
523	20
525	19
527LF	19
529	20
530	18
532	19
600	
646AS	21
646BV	26
646R	26
700	
720Q	5
730	16
750LF	5
752CMLPF	8
752N	6
752UF	8
754DLF	8
754N	6
754PXCEDEL	7
754PXCEL	7
754PXDEL	7
754PXL	7
755	5
755MF	8
757	4
758	8
759	4
759MF	4
759PLF	5
759SDS	35
760	7
770	12
770G	12
770N	12
771	13
772	13
772ST	13
773	13
A	
ADJ	31
AHV	31
AVA	31
AVS	31
AZ203	24
AZ205	24
AZ206	24
AZ207	25
AZ646	25
B	
B1	61
B5	62-63
B6	64-65

ITEM NAME PAGE NUMBER

B7	65
BARV	30
BARVY	30
BARVYN	30
BCV	31
BDVLF	21
BFPLF	21
BSGV	30
C	
CIBF	56
CICF	56
CIF	35
CIRF	56
CK	31
CVC	54
D	
DCVLF	21
E	
EFV	34
EMKL	58
F	
FR	34
FV	34
FY	27
G	
GFF	57
GFFNA	57
GNA	57
GNAX	57
GSFF	57
GSNA	57
GSNAFF	57
GSNAX	57
K	
KEY	31
N	
NT	30
O	
OP	59
OTV	35
P	
PBVC	35
PVCF	56
S	
SBG	57
SC	54
SGV	30
W	
WH	59



MATCO-NORCA

Global sourcing. National compliance. Local service.

www.matco-norca.com

CALIFORNIA

Toll Free: 866-532-8306
Fax: 866-532-8307

TEXAS

Toll Free: 800-935-5456
Fax: 713-680-2999

ILLINOIS

Toll Free: 844-412-5068
Fax: 800-640-2252

NEW YORK

Toll Free: 800-431-2082
Fax: 845-278-9056