



Advanced Heating  
& Hot Water Systems

# High Efficiency UFT COMBI Floor & Wall

## Tankless Water Heater & Space Heating Appliance



### 140K & 199K Btuh Units

Stainless Steel, Fire Tube  
Heat Exchanger

Turndown Ratio up to 10:1

Advanced Modulating Gas  
Condensing Boiler: Up to  
**96% AFUE**

Built-in 2 Gallon Indirect  
Stainless Steel Tank

Universal Piping Location:  
Installer Connection Can  
Easily be Moved from Left  
to Right Side of the Unit

3.2 GPM Flow Rate  
@ 77° Rise (UFTC-140F)

4.8 GPM Flow Rate  
@ 77° Rise (UFTC-199F)

Venting: 2" or 3" PVC, CPVC  
or Polypropylene

[www.htproducts.com](http://www.htproducts.com)



Save Energy • Save Money • Save Space • Save On Installation

**Intake**

**Exhaust**

**Automatic Air Vent**

**Modulating Gas Valve**

**DHW Heat Exchanger**

- Premium grade stainless steel
- Minimizes calcium deposits
- Sufficient hot water flow
- Instantaneous Response

**Turbo Fan**

Modulating fan provides significant power for long vent runs

**Ceramic Fiber Burner**

The Eco Pre-Mixed burner offers high combustion efficiency and low CO and NOx emissions

**Heat Exchanger**

- Hi-fin heat exchanger
- Higher efficiency
- Lower pressure drop
- Compact storage size

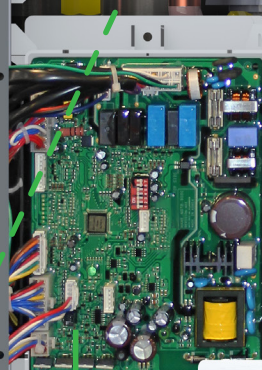

NATIONAL BOARD NO. \_\_\_\_\_  
 CERTIFICATED BY  
 KITURAMI CO., LTD.  
 MAWP, WATER \_\_\_\_\_ 30PSI  
 MAXIMUM WATER \_\_\_\_\_ 200 F  
 HEATING SURFACE \_\_\_\_\_ 24 SQ. FT.  
 MIN. RELIEF VALVE CAP. 2000000 U/H  
 SERIAL NO. \_\_\_\_\_  
 YEAR BUILT \_\_\_\_\_



**Main Control**

- Multiple safety functions
- Built in dual stage anti-freezing mechanism

**Built-In Threeway Valve and High Efficiency Pump**

Optimizes overall efficiency

**Condensate Trap**

**CH Pressure Gauge**

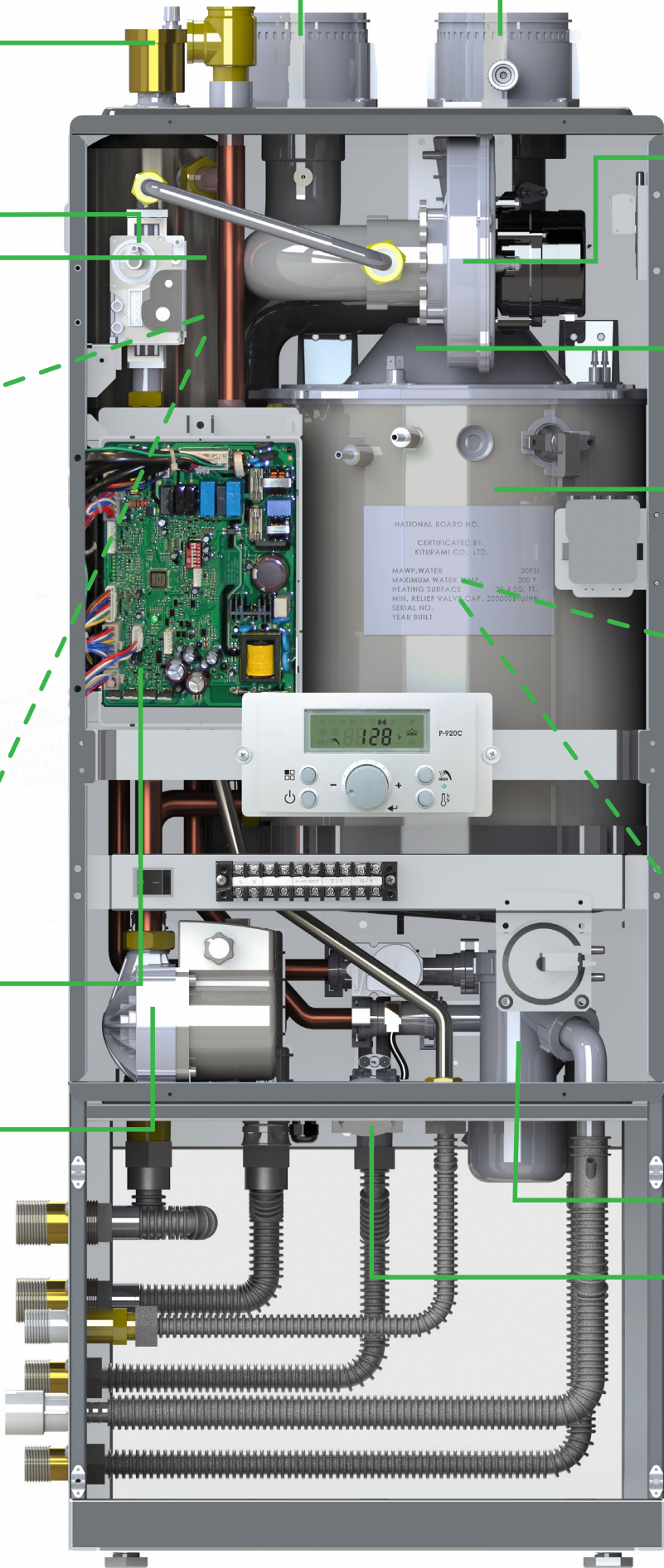

# MULTIPLE VENTING CONFIGURATIONS

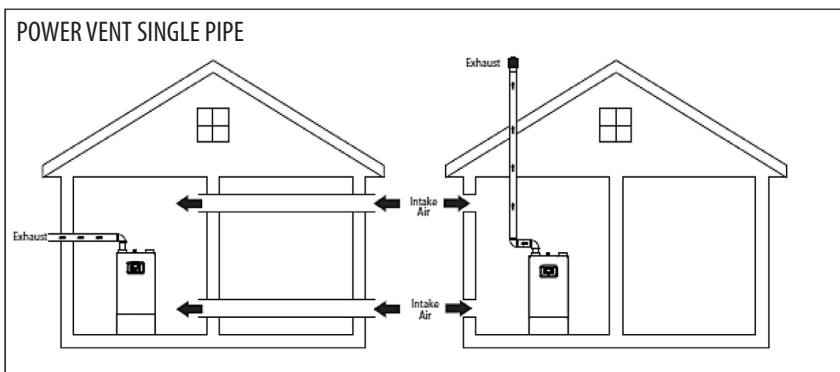
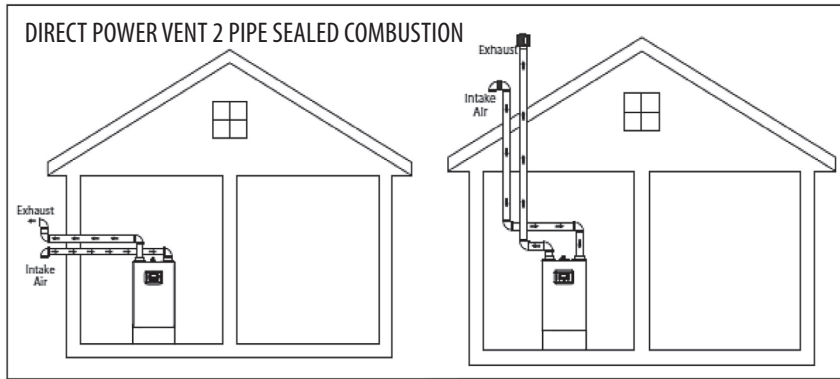

**Combined Vent Length:** 2"(50ft), 3"(100ft)  
**Vent Materials:** CPVC, PVC, PP & Power Vent

# MULTIFUNCTION CONTROL PANEL

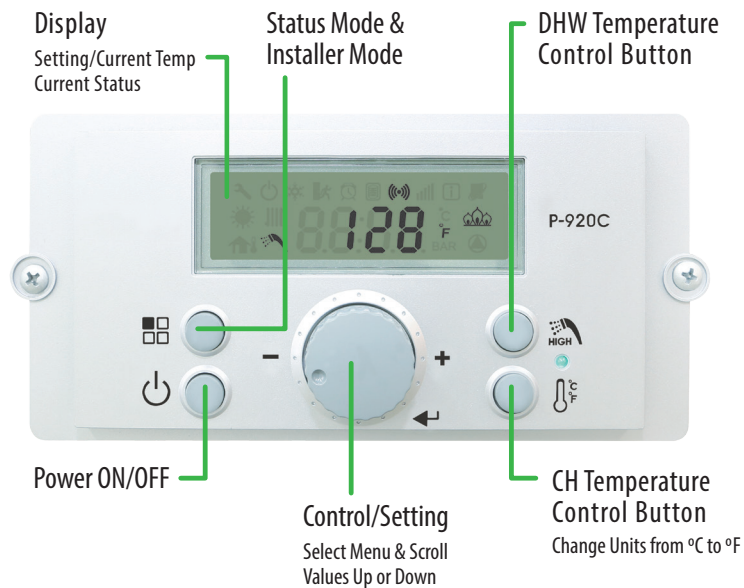

# TESTING



All UFT Combi Units are properly Tested and Assembled in Massachusetts to ensure that its quality is at the highest level



# CONNECTIONS

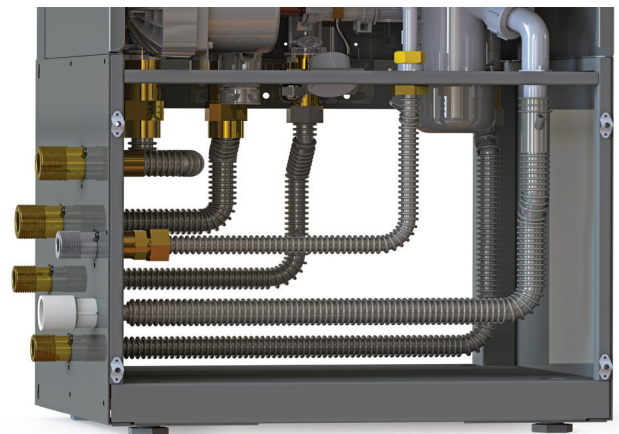

**Domestic Inlet/Outlet** 3/4" NPT  
**Boiler Inlet/Outlet** 1" NPT  
**Gas Inlet** 3/4" NPT  
**Condensate Drain** 3/4" PVC

All the bottom connections (Boiler Outlet & Inlet / Domestic Outlet & Inlet / Condensation / Gas) can be located on either side of the boiler (Left or Right) to make installation easier. Note: Fittings are shipped on left side of the boiler.

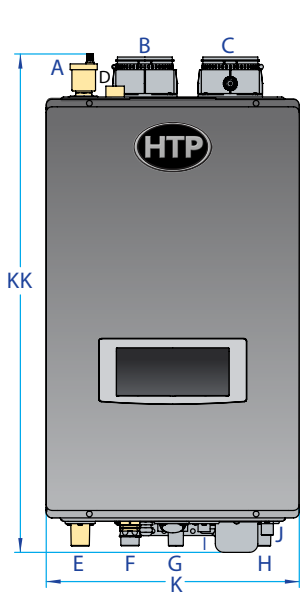

Wall Units



Replace \* with a W (for a wall unit) or a F (for a floor unit)

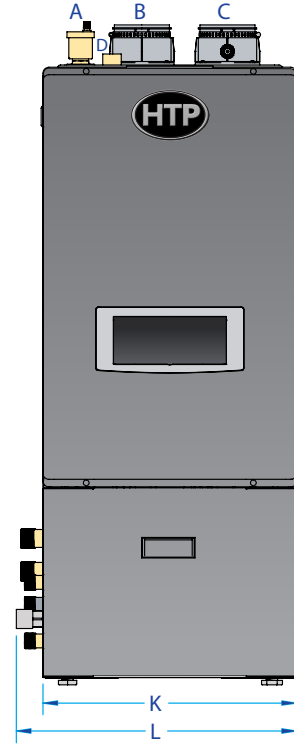
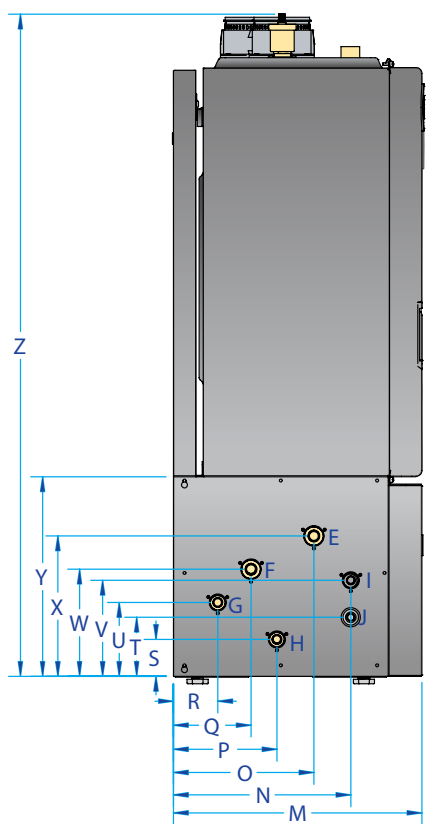

All the bottom connections (boiler, domestic, condensation & gas) can be located on either side of the unit. Fittings are shipped on the left side of the boiler.

Floor Units

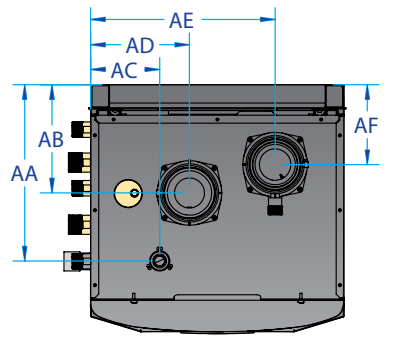

UFT Combi		
	DESCRIPTION	DIAMETER
A	AUTOMATIC AIR VENT	-
B	INTAKE PIPE CONNECTION	3"
C	EXHAUST PIPE CONNECTION	3"
D	PRESSURE RELIEF VALVE ADAPTER	3/4" NPTF
E	CH SUPPLY ADAPTER	1" NPT
F	CH RETURN ADAPTER	1" NPT
G	DHW OUTLET ADAPTER	3/4" NPT
H	DHW INLET ADAPTER	3/4" NPT
I	GAS CONNECTION ADAPTER	3/4" NPT
J	CONDENSATE ADAPTER	3/4" PVC

MODELS	K	KK	L	M	N	O	P	Q	R	S	T	U	V	W	X	Y	Z	AA	AB	AC	AD	AE	AF
UFTC-140*	17.3	34	19.1	16.8	12	9.5	7	5.3	3	2.5	4	5	6.5	7.3	9.5	13.5	44.8	12	7.4	4.7	6.8	12.6	5.5
UFTC-199*	19.7	37	21.5	18.2	13.3	10.8	8.3	6.6	4.3	2.5	4	5	6.5	7.3	9.5	13.5	48	14	8.5	3.2	9.2	15.1	5.2

Model		UFTC-140*	UFTC-199*
DHW Input	Natural Gas or Propane Gas	14,000 ~ 140,000 Btuh	19,000 ~ 199,000 Btuh
Boiler Input / AFUE		14,000 ~ 140,000 Btuh / 96	19,900 ~ 140,000 Btuh / 95.1
Floor Model Dimensions (W x H x D)		W 19" x H 45" x D 17"	W 22" x H 48" x D 18"
Wall Mount Model Dimensions (W x H x D)		W 17.3" x H 34" x D 15.4"	W 19.7" x H 37" x D 16.8"
Installation Type		Indoor, Wall Mounted Model or Floor Model, Fully Condensing	
Venting Type		Forced Draft Direct-Vent	
Venting: Combined Vent Length / Materials		2"(50ft), 3"(100ft) / CPVC, PVC, PP & Power Vent	
Ignition		Electronic Ignition	
Gas Supply Pressure	Natural Gas	3.5"W.C ~ 14"W.C	
	Propane Gas	3.5"W.C ~ 14"W.C	
Power Supply	Main Supply	AC 120V / 60Hz	
	Maximum Power Consumption	160W	
Flow Rate (DHW)	35°F (19°C) Temp Rise	7.1 gal/m	9.88 GPM
	45°F (25°C) Temp Rise	5.5 gal/m	7.7 GPM
	77°F (43°C) Temp Rise	3.2 gal/m	4.8 GPM
Water Pressure	Central Heating	15 min - 30 max PSI	
	Domestic Hot Water	15 min - 150 max PSI	
Connection Sizes	Cold Water Inlet / Hot Water Outlet	3/4" NPT	
	Boiler Inlet/Outlet	1" NPT	
	Gas Inlet	3/4" NPT	
Warranty		Limited 10 Year Residential Warranty	

In accordance with our company policy of ongoing product improvement, HTP Comfort Solutions, LLC. reserves the right to make changes without prior notice. MKTLIT-XX - 02/2018 © HTP Comfort Solutions LLC.