

## FSA1BG Series

iQ Drive®

### Ultra High Efficiency Air Conditioner 20 SEER Residential System 2-5 Ton Capacities

The iQ Drive® air conditioner system features modulating compressor technology and variable speed indoor and outdoor fan motors. This system is controlled from a two stage cooling and heating thermostat. The system has the capability of adding up to 18% of additional cooling above the rated capacity. The air handler has de-humidification capabilities from the thermostat or duct mounted humidistat.

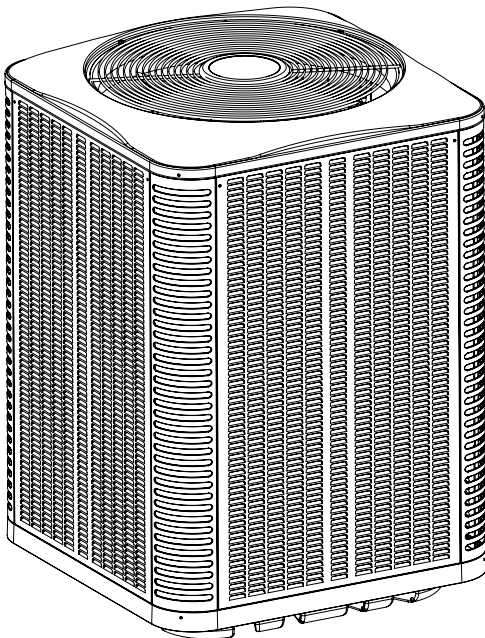

## FEATURES and BENEFITS

- **iQ Drive®:** Inverter driven Samsung rotary compressor provides five capacities in modulating operation from a two stage thermostat.
- **Interface Control Board:** Two digit LED provides system operation, status and diagnostic troubleshooting information.
  - **System Control:** Utilizes a patented capacity control algorithm to select the optimum system capacity level.
  - **System Protection:** Internal controls monitor system operation to protect the inverter drive and compressor.
  - **Cooling operating temperature range:** 50 °F to 125 °F.
  - **Five Minute Restart Time Delay:** When the unit shuts down, a delay keeps the unit from restarting, eliminating the highest cause for compressor failure.
- **Compressor and Component Access:** Designed to make servicing easier for the contractor, hinge access panels are provided to all controls and the compressor.
- **High Efficiency with the low Sound Levels:** 20 SEER with sound ratings of 57-76 depending upon operating conditions.
- **Compressor Sound Blanket:** Engineered to significantly reduce unwanted compressor noise.
- **Variable Speed Condenser Motor and Swept-Wing Fan Blade:** A heavy duty brushless DC motor for long lasting reliability and engineered to provide quiet operation. Requires no maintenance and is completely protected from rain and snow.
- **Service Port:** This port allows the contractor to read the suction pressure in all modes of operation without removing any panels, saving time and increasing serviceability.
- **High Pressure Switch:** Protects against abnormally high system pressures. Auto-reset feature prevents nuisance service visits.
- **Low Pressure Switch:** Protects against loss of system refrigerant charge.
- **Liquid Line Filter Drier:** Included with unit, field installed.
- **Micro-Channel Coils:** All-Aluminum coils are designed to optimize heat transfer, and increase durability and reliability.
- **Composite Base Pan:** Absorbs sound and is corrosion resistant. Composite pan is also stronger and lighter than steel.
- **Designed Using Galvanized Steel:** With a polyester urethane coat finish, it passes 950 hours of salt spray per ASTM Std. B117.
- **One Piece Top/Orifice:** Designed for maximum airflow and quiet operation.
- **Removable Top Grille Assembly:** Allows ease of service from the top without disconnecting fan motor leads.
- **Service-Friendly Jacket:** Side panels can be easily removed and replaced without removing the top grill.



# MODEL IDENTIFICATION CODES

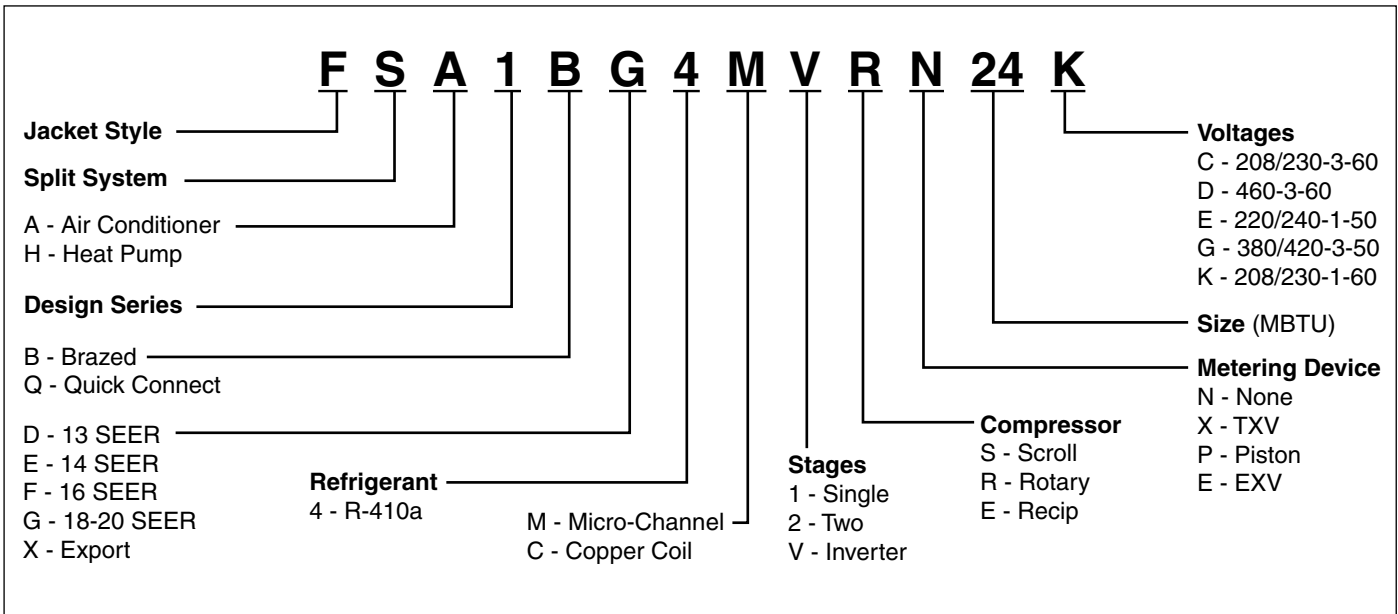

## DIMENSIONS

### AIR CONDITIONER OUTDOOR SECTION

FSA1BG	24K	36K	48K	60K
H	37	37	45	45
W	22 1/2	30 1/2	30 1/2	30 1/2
D	22 1/2	30 1/2	30 1/2	30 1/2

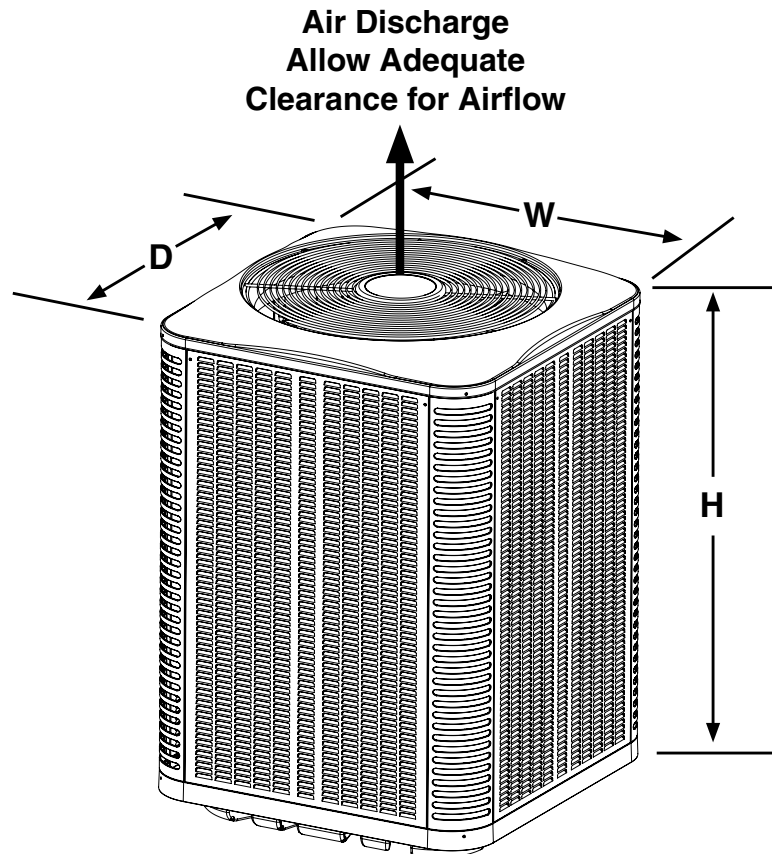

# PHYSICAL AND ELECTRICAL SPECIFICATIONS / OUTDOOR UNITS

## 20 SEER — Ultra High Efficiency

Model Number FSA1BG		24K	36K	48K	60K	
<b>ELECTRICAL DATA</b>	Volts-Cycles-Phase <sup>(1)</sup>	208/230-60-1				
	Total Amps	11.9	17.3	18.9	28.8	
	Delay Fuse Max. <sup>(2)</sup>	20	35	35	60	
	Min. Circuit Ampacity	14.2	21	23	35.1	
	Field Control Wiring Connections (24 vac from thermostat/indoor side)	R, C, Y1, Y2				
<b>COMPONENT DATA</b>	Fan Motor	Type	Brushless DC			
		Amps	2.6	2.6	2.6	3.8
		HP	1/3	1/3	1/3	1/2
	Compressor Data	RLA	9.3	14.7	16.3	25
		LRA	N/A	N/A	N/A	N/A
	Service Valves	Liquid Side	3/8"	3/8"	3/8"	3/8"
		Vapor Side	3/4"	7/8"	7/8"	7/8"
<b>Installation Refrigerant Vapor Line Size (All liquid lines 3/8" OD)</b>	0 - 24 ft. equiv.	3/4"	7/8"	7/8"	7/8"	
	25 - 39 ft. equiv.	3/4"	7/8"	1-1/8"	1-1/8"	
	40 - 75 ft. equiv. <sup>(4)</sup>	7/8"	1-1/8"	1-1/8"	1-1/8"	
	75 - 100 ft. equiv. <sup>(4)</sup>	1-1/8"	1-1/8"	1-1/8"	1-1/8"	
<b>Weight, lbs. (approximate)</b>	Net	166	218	246	261	
	Ship	174	229	259	274	
<b>Sound Level dB</b>	Minimum	57	60	61	63	
	Maximum	68	68	70	71	

(1) Operating Voltage Range: 187 vac min. to 253 vac max.

(2) HACR Type circuit breakers may be used.

(3) Additional charge for longer line sets as follows (with 3/8" liquid lines):

3/4" vapor line: 0.6 oz per additional foot

7/8" vapor line: 0.7 oz per additional foot

1-1/8" vapor line: 0.8 oz per additional foot

Minimum outdoor temperature for cooling is 50°F.

Sound levels measured at 10 feet.

(4) Refrigerant Tubing Limitations-The compressor manufacturer imposes a maximum equivalent line set length of 100 ft. Furthermore, vertical elevation shall not exceed 50 ft.

(6) For additional charging instructions please refer to the QRD.

See current AHRI Directory for certified combinations and ratings.

[www.ahridirectory.org](http://www.ahridirectory.org)

COPPER WIRE SIZE — AWG (1% Voltage Drop)				
Supply Wire Length-Feet				Supply Circuit
200	150	100	50	Ampacity
6	8	10	14	15
4	6	8	12	20
4	6	8	10	25
4	4	6	10	30
3	4	6	8	35
3	4	6	8	40
2	3	4	6	45
2	3	4	6	50

Wire Size based on N.E.C. for 60° type copper conductors.

## PANEL REMOVAL AND REPLACEMENT INSTRUCTIONS

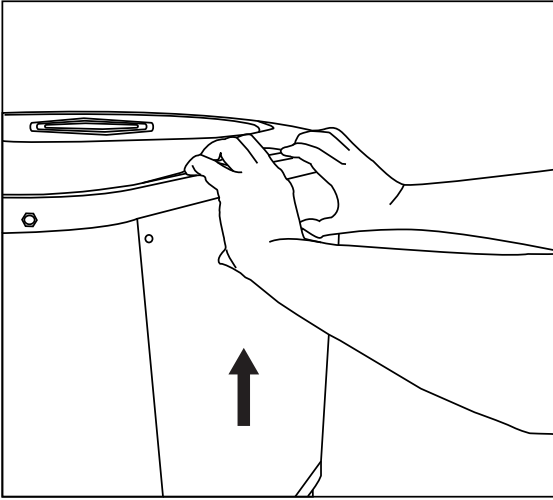

### Removing Panels:

1. Remove screws.
2. Pull up on panel.
3. Rotate bottom of panel out.
4. Pull panel off.

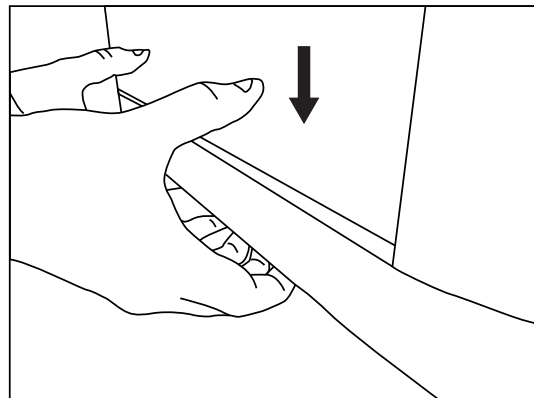
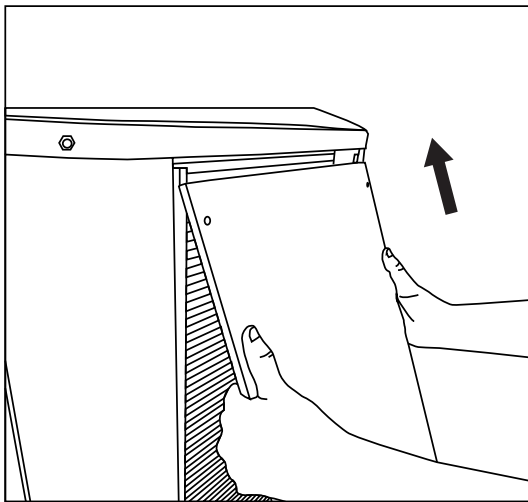
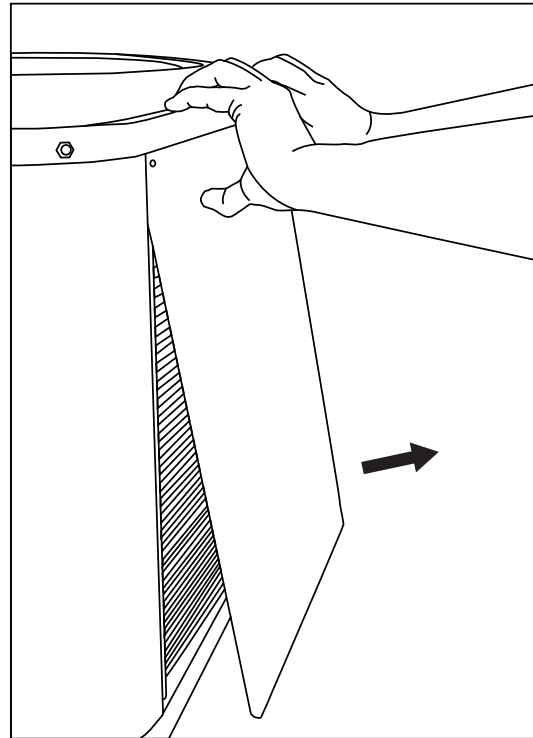

### Reinstalling Panels:

1. Place panel back in towards top of unit.
2. Rotate bottom of panel inwards.
3. Push panel down until it fills gap at bottom of unit.
4. Replace screws.

# SYSTEM CAPACITIES AND MATCHES

## 20 SEER Ultra High Efficiency Air Conditioners

Model Number	Indoor Model Number	Furnace Model Number	Capacity	SEER	EER	CFM 2nd Stg	CFM 1st Stg
FSA1BG4MVRN24K	C7BHMx24C-B	FG7S(*)-B+(*)SHE	23,600	20	13.5	810	540
FSA1BG4MVRN24K	C7BHMx24C-B	FG7T(*)-VB	23,600	20	13.5	810	540
FSA1BG4MVRN24K	C7BHMx24C-B	MB7VM-1600-B	23,600	20	13.5	810	540
FSA1BG4MVRN24K	B6VMMx24K-B		23,600	20	13.5	810	540
FSA1BG4MVRN24K	B6VMMx24K-B		23,600	20	13.5	810	540
FSA1BG4MVRN36K	C7BHMx36C-B	FG7S(*)-B+(*)SHE	35,000	20	12.5	1050	700
FSA1BG4MVRN36K	C7BHMx36C-B	FG7T(*)-VB	35,000	20	12.5	1050	700
FSA1BG4MVRN36K	C7BHMx36C-B	MB7VM-1600-B	35,000	20	12.5	1050	710
FSA1BG4MVRN36K	B6VMMx36K-B		35,000	20	12	1050	710
FSA1BG4MVRN36K	B6VMMx36K-B		35,000	20	12	1050	710
FSA1BG4MVRN36K	C7BHMx36C-C	FG7S(*)-C+(*)SHE	35,000	20	13	1090	730
FSA1BG4MVRN36K	C7BHMx36C-C	FG7T(*)-VC	35,000	20	13	1090	730
FSA1BG4MVRN48K	C7BHMx48C-C	FG7S(*)-C+(*)SHE	45,500	20	12.5	1480	990
FSA1BG4MVRN48K	C7BHMx48C-C	FG7T(*)-VC	45,500	20	12.5	1480	990
FSA1BG4MVRN48K	C7BHMx48C-C	MB7VM-2000-C	45,500	20	12.5	1480	990
FSA1BG4MVRN48K	B6VMMx48K-C		46,000	20	13	1480	990
FSA1BG4MVRN48K	B6VMMx48K-C		46,000	20	13	1480	990
FSA1BG4MVRN48K	C7BHMx48C-D	FG7S(*)-D+(*)SHE	46,000	20	13	1480	990
FSA1BG4MVRN48K	C7BHMx48C-D	FG7T(*)-VD	46,000	20	13	1480	990
FSA1BG4MVRN60K	C7BHMx60C-C	FG7S(*)-C+(*)SHE	54,500	20	11.7	1675	1120
FSA1BG4MVRN60K	C7BHMx60C-C	FG7T(*)-VC	54,500	20	11.7	1675	1120
FSA1BG4MVRN60K	C7BHMx60C-C	MB7VM-2000-C	54,500	20	11.7	1675	1120
FSA1BG4MVRN60K	B6VMMx60K-C		55,500	20	12.5	1675	1120
FSA1BG4MVRN60K	B6VMMx60K-C		55,500	20	12.5	1675	1120
FSA1BG4MVRN60K	C7BHMx60C-D	FG7S(*)-D+(*)SHE	55,500	20	12	1675	1120
FSA1BG4MVRN60K	C7BHMx60C-D	FG7T(*)-VD	55,500	20	12	1675	1120

**Note:** Conditions for Nominal Capacity rating are 80°F dry bulb temperature, 67°F wet bulb temperature (approximately 51% RH) indoors, 95°F outdoor ambient temperature. Minimum outdoor temperature for cooling is 50°F.

See current AHRI Directory for certified combinations and ratings.

[www.ahridirectory.org](http://www.ahridirectory.org)

# COOLING EXPANDED RATINGS WITH VARIABLE SPEED AIR HANDLER

## First Stage Low Speed (C1) Cooling

### FSA1BG4MVRN24K with B6VMMX24K-B Air Handler

Outdoor Temperature:			65°F			75°F			85°F			95°F			105°F			115°F		
Blower cfm	Indoor EDB	Indoor EWB	T.C.	S.C.	kW	T.C.	S.C.	kW	T.C.	S.C.	kW	T.C.	S.C.	kW	T.C.	S.C.	kW	T.C.	S.C.	kW
470	80	62	10.92	10.68	0.32	10.47	10.23	0.40	10.01	9.77	0.48	9.52	9.31	0.56	9.01	8.83	0.70	8.47	8.33	0.78
	80	67	11.53	9.47	0.31	10.93	9.22	0.39	10.34	8.98	0.48	9.75	8.72	0.56	9.15	8.46	0.70	8.55	8.19	0.78
	80	72	12.74	7.36	0.28	12.14	7.09	0.37	11.49	6.86	0.46	10.81	6.65	0.55	10.09	6.45	0.70	9.33	6.24	0.79
	75	62	10.57	9.12	0.34	10.03	8.93	0.42	9.48	8.69	0.50	8.91	8.40	0.58	8.33	8.05	0.71	7.73	7.66	0.79
550	80	62	11.45	11.20	0.32	10.98	10.73	0.40	10.48	10.24	0.48	9.95	9.73	0.57	9.39	9.19	0.71	8.80	8.63	0.79
	80	67	11.82	10.39	0.31	11.24	10.18	0.40	10.64	9.93	0.49	10.02	9.62	0.57	9.36	9.26	0.71	8.68	8.68	0.79
	80	72	12.94	7.93	0.29	12.30	7.69	0.38	11.65	7.46	0.47	10.97	7.24	0.56	10.27	7.03	0.70	9.54	6.80	0.79
	75	62	10.89	9.97	0.34	10.35	9.78	0.42	9.79	9.50	0.50	9.22	9.12	0.59	8.64	8.64	0.72	8.05	8.05	0.80
630	80	62	11.98	11.73	0.31	11.48	11.24	0.39	10.94	10.71	0.48	10.37	10.15	0.57	9.77	9.55	0.71	9.12	8.92	0.80
	80	67	12.01	11.25	0.31	11.47	10.96	0.39	10.89	10.66	0.48	10.25	10.25	0.57	9.57	9.57	0.71	8.84	8.84	0.80
	80	72	13.13	8.51	0.29	12.47	8.29	0.38	11.80	8.07	0.47	11.13	7.85	0.56	10.45	7.62	0.71	9.76	7.38	0.80
	75	62	11.21	10.85	0.33	10.66	10.66	0.42	10.09	10.09	0.50	9.52	9.52	0.59	8.95	8.95	0.72	8.36	8.36	0.81

## Second Stage Rating Speed (C4) Cooling

### FSA1BG4MVRN24K with B6VMMX24K-B Air Handler

Outdoor Temperature:			65°F			75°F			85°F			95°F			105°F			115°F		
Blower cfm	Indoor EDB	Indoor EWB	T.C.	S.C.	kW	T.C.	S.C.	kW	T.C.	S.C.	kW	T.C.	S.C.	kW	T.C.	S.C.	kW	T.C.	S.C.	kW
700	80	62	24.05	20.93	1.09	23.14	20.39	1.27	22.14	19.84	1.47	21.05	19.26	1.68	19.88	18.65	1.92	18.62	17.96	2.15
	80	67	26.97	18.47	1.07	25.82	18.05	1.26	24.54	17.52	1.45	23.25	16.97	1.66	22.09	16.47	1.88	21.17	16.14	2.10
	80	72	29.46	14.54	1.04	28.38	14.05	1.24	27.12	13.60	1.45	25.70	13.16	1.67	24.10	12.71	1.91	22.34	12.22	2.14
	75	62	24.77	17.55	1.07	23.84	17.15	1.26	22.76	16.68	1.45	21.56	16.12	1.67	20.21	15.45	1.90	18.73	14.67	2.14
820	80	62	24.83	22.60	1.11	23.82	22.01	1.30	22.80	21.38	1.50	21.75	20.72	1.71	20.68	20.03	1.95	19.59	19.30	2.18
	80	67	27.61	19.96	1.08	26.37	19.52	1.28	25.04	18.96	1.48	<b>23.73</b>	<b>18.37</b>	<b>1.68</b>	22.53	17.81	1.91	21.55	17.38	2.14
	80	72	30.23	15.54	1.06	29.05	15.08	1.27	27.70	14.61	1.48	26.20	14.14	1.70	24.59	13.65	1.94	22.87	13.13	2.17
	75	62	25.46	18.90	1.09	24.43	18.47	1.28	23.30	17.94	1.47	22.05	17.32	1.69	20.71	16.60	1.93	19.25	15.76	2.17
940	80	62	25.61	24.34	1.14	24.51	23.69	1.33	23.45	22.98	1.54	22.44	22.22	1.75	21.47	21.42	1.98	20.55	20.55	2.21
	80	67	28.25	21.50	1.10	26.91	21.03	1.29	25.54	20.45	1.50	24.21	19.81	1.71	22.98	19.19	1.95	21.92	18.65	2.17
	80	72	31.01	16.58	1.08	29.71	16.14	1.29	28.27	15.66	1.51	26.71	15.15	1.73	25.07	14.62	1.97	23.40	14.07	2.19
	75	62	26.16	20.29	1.11	25.03	19.82	1.29	23.83	19.25	1.50	22.55	18.57	1.71	21.20	17.78	1.96	19.78	16.89	2.21

## Boost Speed (C5) Cooling

### FSA1BG4MVRN24K with B6VMMX24K-B Air Handler

Outdoor Temperature:			65°F			75°F			85°F			95°F			105°F			115°F		
Blower cfm	Indoor EDB	Indoor EWB	T.C.	S.C.	kW	T.C.	S.C.	kW	T.C.	S.C.	kW	T.C.	S.C.	kW	T.C.	S.C.	kW	T.C.	S.C.	kW
700	80	62	26.33	21.89	1.41	25.33	21.39	1.61	24.18	20.84	1.83	22.97	20.30	2.07	21.79	19.83	2.33	20.74	19.49	2.61
	80	67	29.36	19.16	1.41	28.27	18.64	1.63	26.88	18.01	1.86	25.39	17.36	2.12	23.95	16.80	2.39	22.77	16.45	2.69
	80	72	32.38	15.68	1.37	31.15	15.13	1.60	29.80	14.62	1.84	28.33	14.11	2.10	26.70	13.59	2.38	24.92	13.03	2.68
	75	62	27.31	18.55	1.42	26.27	18.17	1.62	24.79	17.62	1.84	23.15	17.08	2.07	21.68	16.72	2.33	20.67	16.79	2.59
820	80	62	27.33	23.88	1.45	26.24	23.28	1.65	24.97	22.57	1.87	23.68	21.86	2.12	22.56	21.33	2.38	21.77	21.12	2.67
	80	67	30.17	20.67	1.45	29.05	20.17	1.65	27.77	19.63	1.88	26.33	19.03	2.14	24.75	18.36	2.43	23.06	17.61	2.74
	80	72	33.30	16.70	1.41	32.02	16.15	1.64	30.58	15.61	1.88	29.00	15.09	2.15	27.31	14.58	2.43	25.54	14.06	2.73
	75	62	28.06	19.97	1.45	26.94	19.44	1.66	25.53	18.85	1.88	24.01	18.27	2.12	22.55	17.81	2.38	21.31	17.58	2.65
940	80	62	28.33	25.96	1.48	27.15	25.26	1.68	25.76	24.36	1.91	24.40	23.49	2.16	23.33	22.88	2.44	22.79	22.79	2.73
	80	67	31.11	22.30	1.48	29.91	21.67	1.70	28.50	21.00	1.94	26.94	20.33	2.20	25.35	19.70	2.49	23.81	19.17	2.80
	80	72	34.22	17.74	1.44	32.90	17.19	1.67	31.37	16.64	1.92	29.68	16.11	2.19	27.92	15.60	2.48	26.16	15.13	2.78
	75	62	28.81	21.43	1.48	27.60	20.75	1.69	26.27	20.11	1.92	24.87	19.50	2.17	23.41	18.92	2.43	21.94	18.37	2.70

E.D.B. = Entering dry bulb    E.W.B. = Entering wet bulb    T.C. = Total Capacity    S.C. = Sensible Capacity    kW = Kilo Watts

NOTE: For outdoor temperature ranges that are blank, values are omitted because the interface controller may reduce compressor speed for protection.

# COOLING EXPANDED RATINGS WITH VARIABLE SPEED AIR HANDLER (CONT.)

## First Stage Low Speed (C1) Cooling FSA1BG4MVRN36K with B6VMMX36K-B Air Handler

Outdoor Temperature:			65°F			75°F			85°F			95°F			105°F			115°F		
Blower cfm	Indoor EDB	Indoor EWB	T.C.	S.C.	kW	T.C.	S.C.	kW	T.C.	S.C.	kW	T.C.	S.C.	kW	T.C.	S.C.	kW	T.C.	S.C.	kW
630	80	62	16.45	15.93	0.49	15.69	15.35	0.61	14.93	14.71	0.73	14.20	14.01	0.85	13.48	13.27	1.13	12.77	12.49	1.25
	80	67	17.72	13.72	0.47	16.80	13.49	0.59	15.87	13.14	0.72	14.93	12.68	0.85	13.98	12.13	1.13	13.01	11.48	1.26
	80	72	19.61	10.63	0.43	18.74	10.34	0.56	17.80	10.02	0.69	16.77	9.67	0.82	15.67	9.28	1.10	14.49	8.83	1.23
	75	62	16.61	13.16	0.50	15.74	12.84	0.62	14.84	12.49	0.74	13.91	12.09	0.86	12.93	11.65	1.14	11.93	11.14	1.26
710	80	62	17.11	16.66	0.49	16.34	16.02	0.61	15.57	15.32	0.73	14.79	14.56	0.86	14.01	13.74	1.13	13.22	12.88	1.26
	80	67	18.03	14.70	0.47	17.10	14.46	0.60	16.15	14.08	0.73	15.19	13.60	0.86	14.22	13.00	1.14	13.24	12.31	1.27
	80	72	19.91	11.27	0.44	19.03	10.98	0.57	18.06	10.67	0.70	17.01	10.32	0.83	15.87	9.92	1.11	14.64	9.47	1.24
	75	62	16.94	14.08	0.50	16.04	13.70	0.63	15.11	13.32	0.75	14.16	12.92	0.87	13.17	12.49	1.15	12.16	12.00	1.27
790	80	62	17.77	17.39	0.49	17.00	16.69	0.61	16.21	15.93	0.74	15.39	15.10	0.86	14.54	14.21	1.14	13.68	13.27	1.27
	80	67	18.34	15.67	0.48	17.39	15.41	0.60	16.43	15.03	0.73	15.45	14.52	0.86	14.46	13.90	1.14	13.46	13.18	1.28
	80	72	20.21	11.93	0.44	19.31	11.64	0.58	18.33	11.33	0.71	17.25	10.98	0.84	16.07	10.58	1.12	14.80	10.12	1.25
	75	62	17.27	15.05	0.51	16.34	14.62	0.63	15.38	14.17	0.75	14.41	13.70	0.88	13.41	13.18	1.15	12.39	12.39	1.28

## Second Stage Rating Speed (C4) Cooling FSA1BG4MVRN36K with B6VMMX36K-B Air Handler

Outdoor Temperature:			65°F			75°F			85°F			95°F			105°F			115°F		
Blower cfm	Indoor EDB	Indoor EWB	T.C.	S.C.	kW	T.C.	S.C.	kW	T.C.	S.C.	kW	T.C.	S.C.	kW	T.C.	S.C.	kW	T.C.	S.C.	kW
940	80	62	35.85	29.97	1.77	34.27	28.98	2.05	32.69	28.09	2.34	31.10	27.29	2.64	29.51	26.56	2.99	27.92	25.86	3.33
	80	67	39.28	25.81	1.74	38.01	25.47	2.01	36.50	24.89	2.31	34.73	24.05	2.63	32.72	22.96	3.01	30.46	21.61	3.38
	80	72	42.06	20.86	1.73	41.47	20.56	2.01	39.86	19.82	2.31	37.79	18.90	2.63	35.80	18.06	3.00	34.43	17.56	3.36
	75	62	36.67	25.03	1.76	35.01	24.27	2.03	33.36	23.49	2.32	31.72	22.71	2.63	30.09	21.91	2.99	28.47	21.10	3.33
1060	80	62	36.76	31.74	1.81	35.13	30.72	2.09	33.48	29.79	2.38	31.81	28.93	2.69	30.12	28.13	3.04	28.42	27.35	3.38
	80	67	39.84	27.04	1.78	38.58	26.75	2.05	37.06	26.21	2.35	35.29	25.40	2.68	33.28	24.32	3.06	31.01	22.97	3.43
	80	72	42.40	21.64	1.76	42.22	21.51	2.03	40.73	20.80	2.35	38.58	19.85	2.69	36.44	18.97	3.06	34.97	18.49	3.39
	75	62	37.54	26.45	1.79	35.88	25.66	2.07	34.19	24.86	2.37	32.46	24.03	2.68	30.70	23.17	3.04	28.91	22.26	3.39
1180	80	62	37.67	33.57	1.84	35.98	32.51	2.12	34.26	31.53	2.42	32.52	30.62	2.73	30.74	29.74	3.08	28.93	28.87	3.41
	80	67	40.39	28.32	1.81	39.14	28.06	2.09	37.63	27.54	2.39	35.87	26.74	2.71	33.87	25.66	3.10	31.61	24.30	3.47
	80	72	42.73	22.42	1.79	42.96	22.46	2.05	41.57	21.79	2.37	39.34	20.80	2.72	37.04	19.88	3.10	35.46	19.43	3.42
	75	62	38.42	27.92	1.82	36.76	27.10	2.10	35.02	26.26	2.40	33.20	25.38	2.71	31.31	24.45	3.08	29.34	23.46	3.43

## Boost Speed (C5) Cooling FSA1BG4MVRN36K with B6VMMX36K-B Air Handler

Outdoor Temperature:			65°F			75°F			85°F			95°F			105°F			115°F		
Blower cfm	Indoor EDB	Indoor EWB	T.C.	S.C.	kW	T.C.	S.C.	kW	T.C.	S.C.	kW	T.C.	S.C.	kW	T.C.	S.C.	kW	T.C.	S.C.	kW
1025	80	62	40.89	33.51	2.26	39.24	32.66	2.56	37.54	31.81	2.90	35.80	30.93	3.26	34.01	30.02	3.66	32.18	29.06	4.08
	80	67	43.89	28.38	2.24	42.83	27.80	2.54	41.42	27.16	2.88	39.68	26.42	3.27	37.59	25.56	3.69	35.17	24.54	4.15
	80	72	46.63	23.09	2.25	47.16	23.06	2.56	45.78	22.33	2.90	43.40	21.34	3.29	40.93	20.50	3.71	39.27	20.23	4.17
	75	62	41.75	28.17	2.26	40.09	27.38	2.56	38.37	26.57	2.89	36.58	25.72	3.26	34.73	24.83	3.66	32.82	23.89	4.09
1090	80	62	41.45	34.51	2.28	39.81	33.66	2.59	38.10	32.79	2.92	36.32	31.89	3.29	34.47	30.96	3.68	32.55	29.96	4.11
	80	67	44.10	29.00	2.27	43.08	28.48	2.57	41.71	27.89	2.91	40.01	27.19	3.29	37.97	26.38	3.71	35.58	25.39	4.17
	80	72	46.90	23.51	2.28	47.66	23.59	2.58	46.33	22.88	2.93	43.91	21.87	3.31	41.37	21.01	3.74	39.73	20.77	4.20
	75	62	42.27	28.98	2.28	40.65	28.20	2.58	38.92	27.38	2.92	37.10	26.51	3.28	35.17	25.58	3.68	33.13	24.58	4.11
1220	80	62	42.56	36.57	2.31	40.95	35.69	2.62	39.22	34.80	2.96	37.37	33.87	3.33	35.39	32.87	3.73	33.29	31.78	4.16
	80	67	44.52	30.25	2.30	43.58	29.84	2.60	42.30	29.35	2.94	40.68	28.75	3.33	38.72	28.01	3.75	36.41	27.09	4.21
	80	72	47.43	24.36	2.31	48.67	24.67	2.62	47.45	24.01	2.96	44.93	22.96	3.35	42.28	22.07	3.78	40.67	21.90	4.25
	75	62	43.31	30.65	2.30	41.76	29.87	2.61	40.03	29.03	2.95	38.12	28.11	3.32	36.04	27.10	3.72	33.77	25.97	4.15

E.D.B. = Entering dry bulb    E.W.B. = Entering wet bulb    T.C. = Total Capacity    S.C. = Sensible Capacity    kW = Kilo Watts

NOTE: For outdoor temperature ranges that are blank, values are omitted because the interface controller may reduce compressor speed for protection.



# COOLING EXPANDED RATINGS WITH VARIABLE SPEED AIR HANDLER (CONT.)

## First Stage Low Speed (C1) Cooling

### FSA1BG4MVRN48K with B6VMMX48K-C Air Handler

Outdoor Temperature:			65°F			75°F			85°F			95°F			105°F			115°F		
Blower cfm	Indoor EDB	Indoor EWB	T.C.	S.C.	kW	T.C.	S.C.	kW	T.C.	S.C.	kW	T.C.	S.C.	kW	T.C.	S.C.	kW	T.C.	S.C.	kW
940	80	62	23.83	23.54	0.71	22.87	22.55	0.88	22.00	21.67	1.05	21.04	20.73	1.22	19.87	19.60	1.54	18.36	18.16	1.71
	80	67	26.14	19.79	0.68	24.77	19.23	0.85	23.39	18.66	1.02	21.99	18.08	1.20	20.59	17.47	1.53	19.23	16.88	1.71
	80	72	28.49	15.32	0.63	27.30	14.87	0.81	26.00	14.43	1.00	24.59	14.00	1.18	23.07	13.55	1.52	21.49	13.10	1.71
	75	62	24.13	19.02	0.72	22.97	18.56	0.89	21.69	17.96	1.06	20.37	17.31	1.23	19.12	16.68	1.55	18.09	16.20	1.72
990	80	62	24.79	24.45	0.72	23.75	23.41	0.90	22.81	22.50	1.07	21.80	21.53	1.24	20.55	20.33	1.56	18.92	18.78	1.73
	80	67	26.47	21.26	0.70	25.13	20.65	0.87	23.75	20.08	1.05	22.33	19.52	1.23	20.89	18.96	1.56	19.46	18.41	1.74
	80	72	28.79	16.25	0.66	27.63	15.83	0.84	26.33	15.42	1.02	24.89	14.99	1.21	23.32	14.52	1.54	21.66	14.03	1.74
	75	62	24.48	20.42	0.74	23.27	19.92	0.91	22.04	19.38	1.08	20.77	18.77	1.25	19.45	18.08	1.58	18.11	17.32	1.75
1070	80	62	25.45	25.07	0.72	24.35	24.01	0.90	23.38	23.07	1.07	22.27	22.03	1.24	21.01	20.84	1.56	19.30	19.20	1.73
	80	67	26.82	22.49	0.71	25.27	21.94	0.88	23.72	21.30	1.06	22.29	20.67	1.23	20.96	20.06	1.56	19.69	19.42	1.74
	80	72	29.00	16.90	0.66	27.85	16.50	0.84	26.50	16.07	1.03	25.05	15.65	1.21	23.49	15.20	1.55	21.78	14.67	1.75
	75	62	24.72	21.40	0.74	23.47	20.89	0.91	22.22	20.34	1.08	20.99	19.76	1.26	19.67	19.07	1.58	18.12	18.09	1.77

## Second Stage Rating Speed (C4) Cooling

### FSA1BG4MVRN48K with B6VMMX48K-C Air Handler

Outdoor Temperature:			65°F			75°F			85°F			95°F			105°F			115°F		
Blower cfm	Indoor EDB	Indoor EWB	T.C.	S.C.	kW	T.C.	S.C.	kW	T.C.	S.C.	kW	T.C.	S.C.	kW	T.C.	S.C.	kW	T.C.	S.C.	kW
1400	80	62	47.18	40.96	2.31	45.46	40.17	2.63	43.43	39.08	2.96	41.32	37.90	3.31	39.35	36.81	3.70	37.63	35.92	4.08
	80	67	51.43	34.52	2.29	50.07	33.95	2.62	48.17	33.24	2.97	45.79	32.38	3.33	42.96	31.34	3.75	39.76	30.09	4.15
	80	72	54.24	27.30	2.27	54.60	27.26	2.60	52.84	26.48	2.95	49.98	25.41	3.33	46.99	24.52	3.78	43.56	23.56	4.22
	75	62	47.86	33.59	2.37	45.98	32.84	2.75	44.07	32.06	3.10	42.15	31.23	3.43	40.21	30.36	3.76	37.65	28.98	4.03
1480	80	62	48.26	43.81	2.42	46.51	43.04	2.75	44.41	41.78	3.08	42.25	40.31	3.44	40.32	38.91	3.85	38.75	37.73	4.24
	80	67	52.02	36.30	2.41	50.92	35.99	2.73	49.01	35.36	3.07	46.51	34.51	3.45	43.66	33.55	3.88	40.69	32.58	4.31
	80	72	54.61	28.48	2.40	55.44	28.84	2.72	53.72	28.12	3.08	50.70	26.93	3.46	47.60	25.88	3.91	45.58	25.56	4.35
	75	62	49.10	35.77	2.44	47.34	35.11	2.79	45.42	34.32	3.14	43.35	33.38	3.49	41.13	32.28	3.93	38.03	30.44	4.22
1600	80	62	48.99	45.77	2.48	47.22	45.01	2.80	45.08	43.63	3.14	42.89	41.96	3.51	40.99	40.35	3.93	39.50	38.96	4.33
	80	67	52.68	37.63	2.47	51.99	37.68	2.78	49.96	37.06	3.13	47.14	36.09	3.51	44.10	35.10	3.95	41.39	34.48	4.38
	80	72	54.86	29.28	2.46	55.99	29.90	2.78	54.31	29.23	3.14	51.18	27.96	3.52	48.01	26.80	3.97	45.74	26.25	4.41
	75	62	49.89	37.24	2.46	48.20	36.64	2.80	46.34	35.89	3.15	44.24	34.92	3.52	41.81	33.65	3.93	38.29	31.43	4.32

## Boost Speed (C5) Cooling

### FSA1BG4MVRN48K with B6VMMX48K-C Air Handler

Outdoor Temperature:			65°F			75°F			85°F			95°F			105°F			115°F		
Blower cfm	Indoor EDB	Indoor EWB	T.C.	S.C.	kW	T.C.	S.C.	kW	T.C.	S.C.	kW	T.C.	S.C.	kW	T.C.	S.C.	kW	T.C.	S.C.	kW
1400	80	62	53.35	43.94	3.03	51.68	43.18	3.40	49.83	42.34	3.78	47.35	41.03	4.15	43.79	38.78	4.51	37.63	34.15	4.43
	80	67	57.37	37.38	3.05	57.05	37.00	3.43	54.97	36.06	3.78	51.37	34.62	4.09	46.55	32.69	4.38	41.10	30.45	4.37
	80	72	60.46	29.96	3.02	61.67	29.98	3.39	59.37	28.77	3.76	55.99	27.46	4.15	53.94	27.20	4.55	43.56	22.90	4.56
	75	62	55.07	37.12	3.04	53.28	36.17	3.41	50.92	35.11	3.78	48.28	34.10	4.16	45.68	33.31	4.53	37.65	28.54	4.37
1480	80	62	54.49	46.64	3.16	53.05	46.26	3.54	51.05	45.37	3.92	48.42	43.86	4.30	45.09	41.64	4.67	38.75	36.51	4.58
	80	67	57.83	38.90	3.19	58.19	39.37	3.62	56.69	38.92	3.99	52.89	37.18	4.31	47.22	34.26	4.58	41.78	31.52	4.48
	80	72	60.48	30.82	3.15	62.08	31.32	3.52	60.12	30.37	3.90	56.98	29.14	4.29	55.00	28.79	4.68	45.58	24.66	4.70
	75	62	56.19	39.07	3.17	54.78	38.46	3.55	52.29	37.28	3.92	49.51	36.02	4.30	47.19	35.19	4.67	38.03	29.20	4.51
1600	80	62	55.24	48.48	3.22	53.95	48.37	3.61	51.86	47.43	3.99	49.13	45.80	4.37	45.95	43.60	4.75	39.50	38.12	4.66
	80	67	58.69	40.22	3.23	59.15	40.95	3.63	57.06	40.38	3.98	53.09	38.80	4.29	47.88	36.50	4.56	42.22	33.85	4.55
	80	72	60.49	31.39	3.21	62.30	32.19	3.59	60.55	31.42	3.98	57.55	30.23	4.36	55.60	29.81	4.74	45.74	25.21	4.77
	75	62	56.93	40.39	3.23	55.76	40.03	3.61	53.20	38.77	3.99	50.32	37.32	4.37	48.18	36.47	4.75	38.29	29.65	4.58

E.D.B. = Entering dry bulb    E.W.B. = Entering wet bulb    T.C. = Total Capacity    S.C. = Sensible Capacity    kW = Kilo Watts

NOTE: For outdoor temperature ranges that are blank, values are omitted because the interface controller may reduce compressor speed for protection.

# COOLING EXPANDED RATINGS WITH VARIABLE SPEED AIR HANDLER (CONT.)

## First Stage Low Speed (C1) Cooling

### FSA1BG4MVRN60K with B6VMMX60K-C Air Handler

Outdoor Temperature:			65°F			75°F			85°F			95°F			105°F			115°F		
Blower cfm	Indoor EDB	Indoor EWB	T.C.	S.C.	kW	T.C.	S.C.	kW	T.C.	S.C.	kW	T.C.	S.C.	kW	T.C.	S.C.	kW	T.C.	S.C.	kW
990	80	62	23.24	22.64	0.61	22.19	21.72	0.77	21.18	20.75	0.93	20.22	19.73	1.10	19.32	18.68	1.45	18.46	17.61	1.64
	80	67	24.00	20.42	0.60	22.91	19.85	0.77	21.78	19.33	0.94	20.61	18.86	1.10	19.39	18.40	1.45	18.14	17.93	1.62
	80	72	26.17	15.42	0.55	25.03	15.02	0.71	23.79	14.69	0.88	22.44	14.39	1.06	20.98	14.08	1.42	19.43	13.74	1.62
	75	62	22.25	19.67	0.64	21.21	19.31	0.80	20.19	18.80	0.96	19.19	18.16	1.12	18.20	17.39	1.46	17.22	16.52	1.62
1070	80	62	23.71	23.12	0.62	22.64	22.17	0.78	21.62	21.16	0.94	20.63	20.10	1.11	19.69	19.01	1.47	18.80	17.90	1.65
	80	67	24.30	21.34	0.62	23.15	20.81	0.78	22.00	20.22	0.95	20.86	19.57	1.12	19.71	18.86	1.47	18.57	18.11	1.64
	80	72	26.27	15.99	0.56	25.18	15.62	0.73	23.97	15.30	0.90	22.62	15.01	1.08	21.16	14.71	1.44	19.57	14.37	1.63
	75	62	22.45	20.52	0.65	21.34	20.19	0.81	20.30	19.60	0.97	19.34	18.79	1.14	18.46	17.80	1.48	17.65	16.66	1.64
1205	80	62	24.39	23.83	0.62	23.30	22.81	0.78	22.25	21.74	0.95	21.23	20.63	1.12	20.24	19.48	1.47	19.29	18.31	1.65
	80	67	24.74	22.86	0.62	23.50	22.41	0.79	22.33	21.69	0.96	21.22	20.74	1.13	20.17	19.59	1.48	19.18	18.29	1.65
	80	72	26.43	16.94	0.57	25.40	16.60	0.74	24.22	16.32	0.91	22.89	16.06	1.09	21.41	15.77	1.45	19.78	15.41	1.64
	75	62	22.74	21.74	0.65	21.52	21.22	0.81	20.46	20.43	0.98	19.56	19.43	1.14	18.83	18.26	1.49	18.27	16.96	1.65

## Second Stage Rating Speed (C4) Cooling

### FSA1BG4MVRN60K with B6VMMX60K-C Air Handler

Outdoor Temperature:			65°F			75°F			85°F			95°F			105°F			115°F		
Blower cfm	Indoor EDB	Indoor EWB	T.C.	S.C.	kW	T.C.	S.C.	kW	T.C.	S.C.	kW	T.C.	S.C.	kW	T.C.	S.C.	kW	T.C.	S.C.	kW
1480	80	62	56.29	47.82	2.96	54.20	46.69	3.33	51.85	45.45	3.74	49.23	44.06	4.17	46.34	42.49	4.64	43.19	40.68	5.14
	80	67	61.15	40.20	2.98	59.17	39.49	3.37	56.74	38.54	3.78	53.88	37.36	4.22	50.67	35.95	4.69	47.15	34.31	5.20
	80	72	64.80	32.36	2.95	64.48	32.14	3.34	62.14	31.12	3.77	58.72	29.72	4.24	55.18	28.39	4.76	52.44	27.59	5.33
	75	62	56.90	39.56	2.96	54.83	38.60	3.33	52.50	37.51	3.73	49.90	36.28	4.17	47.04	34.89	4.65	43.91	33.29	5.16
1600	80	62	57.25	49.75	2.99	55.10	48.67	3.36	52.68	47.41	3.78	49.98	45.95	4.23	47.00	44.23	4.71	43.75	42.23	5.24
	80	67	61.75	41.66	3.01	59.85	41.03	3.40	57.32	40.07	3.81	<b>54.33</b>	<b>38.86</b>	<b>4.26</b>	51.05	37.47	4.73	47.64	35.99	5.24
	80	72	65.25	33.12	2.98	65.17	33.06	3.37	62.87	32.07	3.80	59.37	30.66	4.28	55.72	29.30	4.80	52.94	28.51	5.36
	75	62	57.83	40.93	2.99	55.66	39.96	3.37	53.23	38.87	3.77	50.52	37.64	4.22	47.55	36.24	4.70	44.30	34.62	5.21
1800	80	62	58.69	52.70	3.17	56.45	51.71	3.55	53.92	50.43	3.97	51.10	48.84	4.44	47.99	46.91	4.96	44.59	44.59	5.52
	80	67	62.66	43.89	3.19	60.87	43.39	3.58	58.20	42.42	4.00	55.01	41.16	4.45	51.62	39.80	4.92	48.38	38.57	5.43
	80	72	65.92	34.28	3.16	66.21	34.45	3.55	63.97	33.53	3.98	60.35	32.09	4.46	56.54	30.68	4.98	53.69	29.91	5.55
	75	62	59.22	43.03	3.18	56.92	42.04	3.56	54.33	40.95	3.97	51.46	39.72	4.42	48.31	38.30	4.90	44.88	36.65	5.41

## Boost Speed (C5) Cooling

### FSA1BG4MVRN60K with B6VMMX60K-C Air Handler

Outdoor Temperature:			65°F			75°F			85°F			95°F			105°F			115°F		
Blower cfm	Indoor EDB	Indoor EWB	T.C.	S.C.	kW	T.C.	S.C.	kW	T.C.	S.C.	kW	T.C.	S.C.	kW	T.C.	S.C.	kW	T.C.	S.C.	kW
1480	80	62	64.82	52.05	4.09	62.38	50.69	4.53	59.67	49.34	5.01	56.73	47.97	5.53	53.57	46.55	6.09	50.21	45.03	6.69
	80	67	69.97	44.06	4.15	68.22	43.30	4.64	65.52	42.11	5.14	62.14	40.63	5.65	58.40	38.99	6.18	54.56	37.36	6.72
	80	72	72.57	37.30	4.14	72.59	36.69	4.66	70.68	35.33	5.19	67.48	33.54	5.73	63.59	31.62	6.28	59.62	29.84	6.84
	75	62	65.67	43.68	4.11	63.41	42.65	4.55	60.62	41.33	5.03	57.54	39.86	5.55	54.43	38.40	6.10	51.53	37.10	6.70
1600	80	62	66.08	54.20	4.13	63.63	52.90	4.58	60.77	51.41	5.07	57.67	49.81	5.60	54.46	48.21	6.16	51.30	46.69	6.77
	80	67	70.79	45.45	4.20	69.37	44.91	4.70	66.66	43.72	5.21	63.10	42.13	5.72	59.18	40.39	6.24	55.35	38.79	6.77
	80	72	73.19	37.70	4.18	73.69	37.46	4.71	71.93	36.31	5.24	68.58	34.58	5.77	64.33	32.61	6.30	59.87	30.69	6.83
	75	62	66.86	45.14	4.14	64.68	44.22	4.58	61.73	42.78	5.07	58.45	41.10	5.60	55.29	39.47	6.18	52.67	38.22	6.80
1800	80	62	67.98	57.50	4.33	65.50	56.30	4.79	62.42	54.59	5.29	59.06	52.65	5.83	55.79	50.75	6.40	52.95	49.23	7.02
	80	67	71.91	47.61	4.36	70.95	47.43	4.86	68.28	46.29	5.37	64.54	44.54	5.91	60.37	42.56	6.47	56.41	40.77	7.05
	80	72	74.12	38.31	4.36	75.34	38.64	4.92	73.79	37.80	5.45	70.24	36.18	5.97	65.46	34.12	6.47	60.24	31.97	6.96
	75	62	68.16	46.80	4.35	66.07	45.74	4.81	63.41	44.63	5.30	60.08	43.32	5.81	56.43	41.99	6.34	53.81	41.59	6.90

E.D.B. = Entering dry bulb    E.W.B. = Entering wet bulb    T.C. = Total Capacity    S.C. = Sensible Capacity    kW = Kilo Watts

NOTE: For outdoor temperature ranges that are blank, values are omitted because the interface controller may reduce compressor speed for protection.

# COOLING EXPANDED RATINGS WITH COIL AND VARIABLE SPEED FURNACE

## First Stage Low Speed (C1) Cooling

### FSA1BG4MVRN24K with FG7 (Variable Speed) and C7BHM24C-B Coil

Outdoor Temperature:			65°F			75°F			85°F			95°F			105°F			115°F		
Blower cfm	Indoor EDB	Indoor EWB	T.C.	S.C.	kW	T.C.	S.C.	kW	T.C.	S.C.	kW	T.C.	S.C.	kW	T.C.	S.C.	kW	T.C.	S.C.	kW
470	80	62	10.90	10.67	0.31	10.45	10.21	0.39	9.98	9.75	0.47	9.49	9.28	0.56	8.97	8.79	0.69	8.43	8.29	0.78
	80	67	11.51	9.46	0.30	10.91	9.21	0.39	10.32	8.95	0.48	9.71	8.70	0.56	9.11	8.43	0.70	8.51	8.15	0.78
	80	72	12.73	7.35	0.28	12.12	7.08	0.37	11.47	6.84	0.46	10.78	6.63	0.55	10.05	6.42	0.69	9.28	6.21	0.78
	75	62	10.55	9.11	0.33	10.01	8.91	0.41	9.46	8.67	0.49	8.88	8.37	0.57	8.29	8.02	0.71	7.69	7.62	0.79
550	80	62	11.43	11.19	0.31	10.96	10.71	0.40	10.45	10.22	0.48	9.92	9.70	0.56	9.35	9.16	0.70	8.76	8.59	0.79
	80	67	11.80	10.38	0.31	11.22	10.17	0.40	10.62	9.91	0.48	9.98	9.59	0.57	9.32	9.23	0.71	8.63	8.63	0.79
	80	72	12.92	7.92	0.29	12.28	7.67	0.38	11.62	7.44	0.47	10.94	7.22	0.56	10.23	7.00	0.70	9.50	6.77	0.79
	75	62	10.88	9.96	0.34	10.33	9.76	0.42	9.76	9.47	0.50	9.19	9.09	0.58	8.60	8.60	0.72	8.01	8.01	0.80
630	80	62	11.97	11.71	0.31	11.46	11.22	0.40	10.92	10.68	0.49	10.34	10.12	0.57	9.73	9.52	0.72	9.08	8.88	0.80
	80	67	11.99	11.24	0.31	11.45	10.94	0.40	10.86	10.64	0.49	10.22	10.22	0.57	9.53	9.53	0.72	8.80	8.80	0.81
	80	72	13.11	8.50	0.30	12.45	8.28	0.39	11.78	8.06	0.48	11.10	7.83	0.57	10.41	7.59	0.71	9.72	7.34	0.80
	75	62	11.20	10.84	0.34	10.64	10.64	0.42	10.07	10.07	0.51	9.49	9.49	0.59	8.91	8.91	0.73	8.32	8.32	0.81

## Second Stage Rating Speed (C4) Cooling

### FSA1BG4MVRN24K with FG7 (Variable Speed) and C7BHM24C-B Coil

Outdoor Temperature:			65°F			75°F			85°F			95°F			105°F			115°F		
Blower cfm	Indoor EDB	Indoor EWB	T.C.	S.C.	kW	T.C.	S.C.	kW	T.C.	S.C.	kW	T.C.	S.C.	kW	T.C.	S.C.	kW	T.C.	S.C.	kW
700	80	62	23.91	20.81	1.11	23.00	20.27	1.30	22.00	19.72	1.49	20.92	19.14	1.70	19.74	18.52	1.94	18.48	17.83	2.17
	80	67	26.84	18.38	1.09	25.68	17.96	1.28	24.40	17.43	1.48	23.12	16.87	1.68	21.95	16.37	1.90	21.03	16.03	2.12
	80	72	29.32	14.47	1.06	28.24	13.98	1.27	26.99	13.53	1.48	25.56	13.09	1.69	23.96	12.63	1.93	22.20	12.14	2.16
	75	62	24.63	17.46	1.10	23.70	17.06	1.28	22.63	16.58	1.48	21.42	16.02	1.69	20.07	15.35	1.93	18.59	14.57	2.17
820	80	62	24.69	22.48	1.15	23.69	21.88	1.34	22.66	21.25	1.54	21.61	20.59	1.75	20.54	19.90	1.99	19.45	19.16	2.22
	80	67	27.48	19.87	1.12	26.23	19.42	1.32	24.90	18.86	1.52	<b>23.59</b>	<b>18.26</b>	<b>1.72</b>	22.39	17.70	1.95	21.41	17.27	2.18
	80	72	30.10	15.47	1.10	28.91	15.01	1.31	27.56	14.54	1.52	26.07	14.07	1.74	24.45	13.57	1.98	22.73	13.05	2.21
	75	62	25.33	18.80	1.13	24.30	18.36	1.32	23.16	17.84	1.51	21.92	17.22	1.73	20.57	16.49	1.97	19.12	15.65	2.21
940	80	62	25.47	24.22	1.19	24.37	23.56	1.39	23.32	22.84	1.59	22.30	22.08	1.81	21.34	21.28	2.04	20.41	20.41	2.26
	80	67	28.11	21.40	1.15	26.78	20.93	1.35	25.41	20.34	1.55	24.07	19.70	1.77	22.84	19.07	2.00	21.78	18.53	2.23
	80	72	30.87	16.51	1.13	29.58	16.06	1.35	28.13	15.58	1.56	26.57	15.07	1.78	24.94	14.54	2.02	23.26	13.99	2.25
	75	62	26.03	20.19	1.16	24.90	19.71	1.35	23.69	19.14	1.55	22.42	18.45	1.77	21.07	17.67	2.02	19.64	16.77	2.26

## Boost Speed (C5) Cooling

### FSA1BG4MVRN24K with FG7 (Variable Speed) and C7BHM24C-B Coil

Outdoor Temperature:			65°F			75°F			85°F			95°F			105°F			115°F		
Blower cfm	Indoor EDB	Indoor EWB	T.C.	S.C.	kW	T.C.	S.C.	kW	T.C.	S.C.	kW	T.C.	S.C.	kW	T.C.	S.C.	kW	T.C.	S.C.	kW
700	80	62	26.20	21.78	1.31	25.19	21.27	1.51	24.04	20.72	1.73	22.83	20.18	1.97	21.66	19.70	2.23	20.60	19.36	2.51
	80	67	29.22	19.07	1.31	28.13	18.55	1.52	26.75	17.92	1.76	25.25	17.26	2.01	23.82	16.70	2.29	22.63	16.35	2.59
	80	72	32.24	15.62	1.27	31.01	15.07	1.50	29.66	14.55	1.74	28.19	14.04	2.00	26.57	13.52	2.28	24.78	12.96	2.57
	75	62	27.18	18.46	1.31	26.14	18.07	1.52	24.65	17.52	1.74	23.02	16.97	1.97	21.54	16.61	2.22	20.54	16.68	2.49
820	80	62	27.20	23.76	1.34	26.10	23.16	1.55	24.83	22.44	1.77	23.55	21.74	2.01	22.42	21.20	2.28	21.63	20.98	2.57
	80	67	30.03	20.58	1.35	28.92	20.08	1.55	27.63	19.53	1.78	26.19	18.93	2.04	24.62	18.26	2.33	22.92	17.51	2.64
	80	72	33.16	16.63	1.30	31.89	16.08	1.53	30.45	15.54	1.78	28.87	15.02	2.05	27.18	14.50	2.33	25.40	13.99	2.62
	75	62	27.93	19.87	1.35	26.80	19.34	1.55	25.40	18.75	1.78	23.88	18.16	2.02	22.41	17.70	2.27	21.17	17.46	2.55
940	80	62	28.20	25.84	1.38	27.01	25.13	1.58	25.62	24.23	1.81	24.26	23.36	2.06	23.19	22.75	2.33	22.66	22.66	2.63
	80	67	30.97	22.21	1.38	29.78	21.57	1.60	28.36	20.90	1.84	26.81	20.22	2.10	25.21	19.59	2.39	23.67	19.05	2.70
	80	72	34.09	17.67	1.34	32.77	17.12	1.57	31.23	16.57	1.82	29.55	16.03	2.09	27.78	15.52	2.37	26.02	15.05	2.68
	75	62	28.68	21.33	1.38	27.46	20.65	1.59	26.14	20.01	1.82	24.73	19.39	2.06	23.28	18.81	2.32	21.81	18.26	2.60

# COOLING EXPANDED RATINGS WITH COIL AND VARIABLE SPEED FURNACE (CONT.)

## First Stage Low Speed (C1) Cooling

### FSA1BG4MVRN36K with FG7 (Variable Speed) and C7BHM36C-B Coil

Outdoor Temperature:			65°F			75°F			85°F			95°F			105°F			115°F		
Blower cfm	Indoor EDB	Indoor EWB	T.C.	S.C.	kW	T.C.	S.C.	kW	T.C.	S.C.	kW	T.C.	S.C.	kW	T.C.	S.C.	kW	T.C.	S.C.	kW
630	80	62	16.40	15.88	0.50	15.63	15.30	0.62	14.88	14.66	0.74	14.14	13.96	0.86	13.42	13.21	1.14	12.70	12.43	1.26
	80	67	17.67	13.68	0.48	16.75	13.45	0.60	15.82	13.10	0.73	14.87	12.64	0.86	13.92	12.07	1.14	12.95	11.42	1.27
	80	72	19.56	10.60	0.44	18.69	10.31	0.57	17.74	9.99	0.70	16.71	9.64	0.83	15.61	9.24	1.11	14.42	8.80	1.24
	75	62	16.56	13.12	0.51	15.69	12.80	0.63	14.79	12.44	0.75	13.85	12.04	0.87	12.87	11.59	1.14	11.87	11.08	1.27
710	80	62	17.06	16.61	0.50	16.29	15.97	0.63	15.52	15.27	0.75	14.74	14.50	0.88	13.95	13.68	1.15	13.16	12.82	1.28
	80	67	17.99	14.66	0.49	17.05	14.41	0.61	16.10	14.04	0.74	15.14	13.55	0.87	14.16	12.95	1.15	13.17	12.26	1.28
	80	72	19.86	11.24	0.45	18.98	10.95	0.59	18.01	10.64	0.72	16.95	10.28	0.85	15.81	9.89	1.13	14.58	9.43	1.25
	75	62	16.89	14.04	0.52	15.99	13.66	0.64	15.06	13.27	0.76	14.10	12.87	0.89	13.11	12.43	1.16	12.10	11.94	1.29
790	80	62	17.72	17.34	0.51	16.95	16.64	0.64	16.15	15.87	0.76	15.33	15.04	0.89	14.48	14.15	1.16	13.61	13.21	1.29
	80	67	18.29	15.62	0.50	17.34	15.37	0.63	16.37	14.98	0.76	15.39	14.47	0.89	14.40	13.85	1.17	13.40	13.12	1.30
	80	72	20.16	11.90	0.47	19.26	11.61	0.60	18.27	11.29	0.74	17.19	10.94	0.87	16.01	10.54	1.14	14.74	10.07	1.27
	75	62	17.22	15.01	0.53	16.28	14.57	0.66	15.33	14.12	0.78	14.35	13.64	0.90	13.35	13.12	1.18	12.33	12.33	1.30

## Second Stage Rating Speed (C4) Cooling

### FSA1BG4MVRN36K with FG7 (Variable Speed) and C7BHM36C-B Coil

Outdoor Temperature:			65°F			75°F			85°F			95°F			105°F			115°F		
Blower cfm	Indoor EDB	Indoor EWB	T.C.	S.C.	kW	T.C.	S.C.	kW	T.C.	S.C.	kW	T.C.	S.C.	kW	T.C.	S.C.	kW	T.C.	S.C.	kW
940	80	62	35.50	29.67	1.83	33.96	28.71	2.10	32.41	27.86	2.39	30.86	27.09	2.70	29.31	26.38	3.05	27.76	25.72	3.39
	80	67	38.92	25.58	1.79	37.70	25.26	2.07	36.22	24.70	2.36	34.50	23.88	2.69	32.52	22.82	3.06	30.30	21.50	3.44
	80	72	41.71	20.68	1.78	41.15	20.41	2.06	39.59	19.69	2.37	37.56	18.78	2.69	35.60	17.96	3.06	34.27	17.48	3.42
	75	62	36.31	24.78	1.81	34.69	24.05	2.09	33.08	23.30	2.38	31.49	22.54	2.69	29.90	21.77	3.04	28.32	20.98	3.39
1060	80	62	36.41	31.44	1.89	34.81	30.44	2.17	33.20	29.54	2.46	31.57	28.72	2.77	29.93	27.94	3.12	28.27	27.20	3.46
	80	67	39.49	26.80	1.86	38.26	26.54	2.13	36.78	26.01	2.43	<b>35.06</b>	<b>25.23</b>	<b>2.76</b>	33.08	24.17	3.14	30.85	22.85	3.51
	80	72	42.05	21.46	1.84	41.91	21.35	2.11	40.45	20.66	2.43	38.35	19.73	2.77	36.24	18.87	3.14	34.81	18.41	3.47
	75	62	37.19	26.20	1.87	35.57	25.44	2.15	33.91	24.66	2.45	32.23	23.85	2.76	30.50	23.02	3.12	28.75	22.14	3.47
1180	80	62	37.31	33.26	1.95	35.67	32.22	2.24	33.99	31.28	2.54	32.28	30.40	2.84	30.54	29.55	3.20	28.77	28.71	3.53
	80	67	40.04	28.07	1.93	38.82	27.84	2.20	37.36	27.34	2.51	35.64	26.56	2.83	33.67	25.51	3.21	31.46	24.18	3.59
	80	72	42.37	22.23	1.91	42.65	22.30	2.17	41.30	21.65	2.49	39.10	20.68	2.84	36.85	19.77	3.22	35.31	19.34	3.54
	75	62	38.07	27.66	1.93	36.45	26.87	2.21	34.74	26.06	2.51	32.97	25.20	2.83	31.11	24.30	3.20	29.19	23.33	3.55

## Boost Speed (C5) Cooling

### FSA1BG4MVRN36K with FG7 (Variable Speed) and C7BHM36C-B Coil

Outdoor Temperature:			65°F			75°F			85°F			95°F			105°F			115°F		
Blower cfm	Indoor EDB	Indoor EWB	T.C.	S.C.	kW	T.C.	S.C.	kW	T.C.	S.C.	kW	T.C.	S.C.	kW	T.C.	S.C.	kW	T.C.	S.C.	kW
940	80	62	39.81	31.93	2.29	38.18	31.12	2.59	36.54	30.31	2.92	34.88	29.49	3.28	33.22	28.65	3.67	31.54	27.78	4.09
	80	67	43.26	27.34	2.27	42.18	26.72	2.56	40.77	26.03	2.90	39.01	25.26	3.28	36.91	24.37	3.70	34.47	23.34	4.16
	80	72	45.94	22.37	2.27	46.20	22.22	2.58	44.80	21.49	2.92	42.52	20.55	3.30	40.17	19.75	3.72	38.54	19.45	4.18
	75	62	40.72	26.89	2.28	39.05	26.12	2.58	37.37	25.34	2.91	35.68	24.55	3.28	33.97	23.74	3.67	32.24	22.90	4.11
1060	80	62	40.84	33.75	2.35	39.23	32.93	2.66	37.57	32.10	2.99	35.85	31.24	3.36	34.07	30.35	3.75	32.23	29.40	4.18
	80	67	43.65	28.48	2.34	42.65	27.96	2.64	41.30	27.37	2.98	39.62	26.68	3.36	37.60	25.87	3.78	35.23	24.89	4.24
	80	72	46.42	23.14	2.35	47.11	23.18	2.65	45.80	22.49	3.00	43.43	21.51	3.38	40.97	20.67	3.80	39.36	20.44	4.26
	75	62	41.67	28.36	2.35	40.08	27.60	2.65	38.39	26.81	2.99	36.62	25.98	3.35	34.77	25.09	3.75	32.83	24.14	4.18
1180	80	62	41.86	35.63	2.42	40.28	34.79	2.73	38.60	33.93	3.07	36.81	33.04	3.44	34.91	32.10	3.84	32.91	31.07	4.27
	80	67	44.04	29.62	2.41	43.11	29.20	2.71	41.85	28.71	3.05	40.24	28.10	3.44	38.29	27.36	3.86	36.00	26.45	4.32
	80	72	46.91	23.92	2.42	48.04	24.18	2.73	46.83	23.52	3.07	44.38	22.50	3.46	41.81	21.64	3.89	40.22	21.47	4.35
	75	62	42.63	29.88	2.41	41.10	29.13	2.72	39.41	28.32	3.06	37.57	27.44	3.43	35.57	26.48	3.83	33.42	25.42	4.26

# COOLING EXPANDED RATINGS WITH COIL AND VARIABLE SPEED FURNACE (CONT.)

## First Stage Low Speed (C1) Cooling

### FSA1BG4MVRN36K with FG7 (Variable Speed) and C7BHM36C-C Coil

Outdoor Temperature:			65°F			75°F			85°F			95°F			105°F			115°F		
Blower cfm	Indoor EDB	Indoor EWB	T.C.	S.C.	kW	T.C.	S.C.	kW	T.C.	S.C.	kW	T.C.	S.C.	kW	T.C.	S.C.	kW	T.C.	S.C.	kW
685	80	62	16.89	16.42	0.47	16.10	15.78	0.59	15.32	15.08	0.72	14.55	14.33	0.84	13.78	13.53	1.11	13.02	12.70	1.24
	80	67	17.92	14.38	0.45	16.97	14.12	0.58	16.01	13.74	0.71	15.05	13.26	0.84	14.08	12.67	1.12	13.10	11.99	1.25
	80	72	19.80	11.06	0.42	18.91	10.76	0.55	17.93	10.43	0.68	16.88	10.08	0.81	15.75	9.68	1.09	14.53	9.23	1.22
	75	62	16.83	13.78	0.48	15.92	13.40	0.61	14.98	13.01	0.73	14.02	12.61	0.85	13.04	12.17	1.13	12.03	11.67	1.25
730	80	62	17.26	16.83	0.47	16.47	16.16	0.60	15.68	15.42	0.72	14.88	14.63	0.84	14.08	13.80	1.12	13.27	12.92	1.25
	80	67	18.10	14.93	0.46	17.14	14.67	0.58	16.17	14.27	0.71	15.20	13.77	0.84	14.22	13.17	1.12	13.23	12.47	1.26
	80	72	19.97	11.43	0.42	19.07	11.13	0.56	18.07	10.80	0.69	17.01	10.45	0.82	15.86	10.05	1.10	14.62	9.59	1.22
	75	62	17.01	14.31	0.49	16.08	13.90	0.61	15.13	13.48	0.73	14.16	13.06	0.86	13.17	12.60	1.13	12.15	12.04	1.26
815	80	62	17.96	17.61	0.47	17.17	16.87	0.60	16.35	16.06	0.72	15.52	15.21	0.85	14.65	14.30	1.13	13.75	13.33	1.26
	80	67	18.42	15.96	0.47	17.45	15.69	0.60	16.46	15.28	0.73	15.47	14.76	0.86	14.48	14.13	1.14	13.47	13.40	1.27
	80	72	20.29	12.13	0.43	19.37	11.83	0.57	18.36	11.50	0.70	17.26	11.15	0.83	16.07	10.75	1.11	14.79	10.28	1.24
	75	62	17.36	15.35	0.50	16.40	14.88	0.62	15.41	14.40	0.74	14.43	13.89	0.87	13.42	13.34	1.14	12.40	12.40	1.27

## Second Stage Rating Speed (C4) Cooling

### FSA1BG4MVRN36K with FG7 (Variable Speed) and C7BHM36C-C Coil

Outdoor Temperature:			65°F			75°F			85°F			95°F			105°F			115°F		
Blower cfm	Indoor EDB	Indoor EWB	T.C.	S.C.	kW	T.C.	S.C.	kW	T.C.	S.C.	kW	T.C.	S.C.	kW	T.C.	S.C.	kW	T.C.	S.C.	kW
1025	80	62	36.52	31.24	1.79	34.90	30.22	2.07	33.27	29.31	2.37	31.63	28.47	2.67	29.97	27.69	3.03	28.30	26.94	3.36
	80	67	39.70	26.69	1.76	38.43	26.39	2.04	36.92	25.84	2.34	35.15	25.02	2.66	33.14	23.93	3.04	30.87	22.59	3.41
	80	72	42.32	21.42	1.74	42.03	21.24	2.02	40.50	20.53	2.33	38.37	19.58	2.67	36.28	18.71	3.04	34.84	18.23	3.37
	75	62	37.31	26.05	1.78	35.65	25.27	2.06	33.97	24.47	2.35	32.27	23.66	2.66	30.55	22.82	3.02	28.80	21.94	3.37
1090	80	62	37.01	32.22	1.81	35.36	31.18	2.09	33.70	30.24	2.38	32.01	29.37	2.69	30.30	28.55	3.04	28.57	27.75	3.38
	80	67	40.00	27.37	1.78	38.74	27.09	2.05	37.23	26.55	2.35	<b>35.46</b>	<b>25.75</b>	<b>2.68</b>	<b>33.45</b>	<b>24.67</b>	<b>3.06</b>	<b>31.19</b>	<b>23.32</b>	<b>3.43</b>
	80	72	42.50	21.84	1.76	42.43	21.76	2.03	40.96	21.06	2.34	38.79	20.10	2.69	36.61	19.21	3.06	35.12	18.74	3.39
	75	62	37.79	26.83	1.79	36.12	26.04	2.07	34.42	25.22	2.36	32.67	24.38	2.68	30.88	23.50	3.04	29.04	22.58	3.39
1220	80	62	37.99	34.21	1.82	36.29	33.14	2.11	34.55	32.15	2.41	32.78	31.21	2.72	30.97	30.31	3.07	29.12	29.12	3.40
	80	67	40.60	28.77	1.79	39.35	28.52	2.07	37.84	28.01	2.38	36.09	27.21	2.70	34.09	26.14	3.09	31.84	24.77	3.46
	80	72	42.85	22.69	1.77	43.23	22.80	2.04	41.88	22.14	2.36	39.62	21.14	2.71	37.27	20.20	3.09	35.65	19.75	3.41
	75	62	38.74	28.43	1.80	37.08	27.61	2.08	35.32	26.76	2.38	33.47	25.86	2.70	31.54	24.91	3.07	29.51	23.88	3.42

## Boost Speed (C5) Cooling

### FSA1BG4MVRN36K with FG7 (Variable Speed) and C7BHM36C-C Coil

Outdoor Temperature:			65°F			75°F			85°F			95°F			105°F			115°F		
Blower cfm	Indoor EDB	Indoor EWB	T.C.	S.C.	kW	T.C.	S.C.	kW	T.C.	S.C.	kW	T.C.	S.C.	kW	T.C.	S.C.	kW	T.C.	S.C.	kW
1025	80	62	40.91	33.52	2.26	39.26	32.68	2.56	37.57	31.83	2.89	35.83	30.95	3.26	34.04	30.04	3.65	32.21	29.09	4.08
	80	67	43.91	28.39	2.24	42.85	27.82	2.54	41.45	27.17	2.88	39.70	26.44	3.26	37.62	25.58	3.68	35.19	24.56	4.14
	80	72	46.65	23.10	2.25	47.19	23.07	2.55	45.81	22.34	2.90	43.43	21.35	3.28	40.96	20.51	3.70	39.30	20.24	4.16
	75	62	41.77	28.18	2.25	40.11	27.40	2.55	38.39	26.58	2.89	36.61	25.74	3.25	34.76	24.85	3.65	32.84	23.91	4.08
1090	80	62	41.47	34.53	2.27	39.83	33.68	2.58	38.13	32.81	2.91	36.35	31.92	3.28	34.50	30.98	3.67	32.58	29.98	4.10
	80	67	44.12	29.01	2.26	43.10	28.50	2.56	41.74	27.90	2.90	40.03	27.21	3.28	37.99	26.39	3.70	35.61	25.41	4.16
	80	72	46.92	23.52	2.27	47.68	23.60	2.57	46.36	22.89	2.92	43.93	21.88	3.30	41.40	21.02	3.73	39.76	20.79	4.19
	75	62	42.29	29.00	2.27	40.67	28.21	2.57	38.95	27.39	2.91	37.12	26.52	3.27	35.19	25.60	3.67	33.16	24.59	4.10
1220	80	62	42.58	36.59	2.29	40.97	35.71	2.60	39.24	34.82	2.94	37.39	33.89	3.31	35.42	32.89	3.71	33.32	31.81	4.14
	80	67	44.55	30.26	2.28	43.61	29.85	2.58	42.33	29.36	2.92	40.70	28.76	3.31	38.74	28.03	3.73	36.44	27.11	4.19
	80	72	47.45	24.37	2.29	48.69	24.68	2.60	47.47	24.02	2.94	44.95	22.97	3.33	42.30	22.08	3.76	40.69	21.92	4.23
	75	62	43.33	30.66	2.28	41.78	29.88	2.59	40.05	29.05	2.93	38.15	28.13	3.30	36.06	27.12	3.70	33.80	25.99	4.13

# COOLING EXPANDED RATINGS WITH COIL AND VARIABLE SPEED FURNACE (CONT.)

## First Stage Low Speed (C1) Cooling

### FSA1BG4MVRN48K with FG7 (Variable Speed) and C7BHM48C-C Coil

Outdoor Temperature:			65°F			75°F			85°F			95°F			105°F			115°F		
Blower cfm	Indoor EDB	Indoor EWB	T.C.	S.C.	kW	T.C.	S.C.	kW	T.C.	S.C.	kW	T.C.	S.C.	kW	T.C.	S.C.	kW	T.C.	S.C.	kW
860	80	62	23.60	23.31	0.74	22.70	22.38	0.91	21.88	21.56	1.08	20.99	20.68	1.25	19.87	19.60	1.57	18.36	18.16	1.74
	80	67	25.91	19.62	0.71	24.60	19.10	0.88	23.27	18.57	1.06	21.94	18.03	1.23	20.59	17.47	1.56	19.23	16.88	1.74
	80	72	28.26	15.20	0.66	27.13	14.77	0.84	25.89	14.37	1.03	24.54	13.97	1.21	23.07	13.55	1.55	21.49	13.10	1.74
	75	62	23.90	18.84	0.75	22.80	18.42	0.92	21.57	17.87	1.09	20.32	17.26	1.26	19.12	16.68	1.58	18.09	16.20	1.75
990	80	62	24.56	24.22	0.76	23.58	23.24	0.94	22.70	22.39	1.11	21.75	21.48	1.28	20.55	20.33	1.60	18.92	18.78	1.77
	80	67	26.24	21.08	0.74	24.95	20.51	0.92	23.64	19.98	1.10	22.28	19.47	1.27	20.89	18.96	1.60	19.46	18.41	1.78
	80	72	28.56	16.12	0.70	27.46	15.73	0.88	26.22	15.35	1.06	24.84	14.96	1.25	23.32	14.52	1.59	21.66	14.03	1.78
	75	62	24.25	20.23	0.78	23.10	19.78	0.95	21.93	19.28	1.12	20.71	18.73	1.30	19.45	18.08	1.62	18.11	17.32	1.80
1080	80	62	25.22	24.84	0.78	24.18	23.84	0.96	23.26	22.96	1.13	22.27	22.03	1.31	21.01	20.84	1.63	19.30	19.20	1.80
	80	67	26.58	22.30	0.77	25.10	21.79	0.94	23.66	21.25	1.12	22.29	20.67	1.30	20.96	20.06	1.63	19.69	19.42	1.81
	80	72	28.76	16.76	0.73	27.68	16.40	0.91	26.44	16.04	1.09	25.05	15.65	1.28	23.49	15.20	1.62	21.78	14.67	1.81
	75	62	24.49	21.20	0.81	23.30	20.74	0.98	22.17	20.28	1.15	20.99	19.76	1.32	19.67	19.07	1.65	18.12	18.09	1.83

## Second Stage Rating Speed (C4) Cooling

### FSA1BG4MVRN48K with FG7 (Variable Speed) and C7BHM48C-C Coil

Outdoor Temperature:			65°F			75°F			85°F			95°F			105°F			115°F		
Blower cfm	Indoor EDB	Indoor EWB	T.C.	S.C.	kW	T.C.	S.C.	kW	T.C.	S.C.	kW	T.C.	S.C.	kW	T.C.	S.C.	kW	T.C.	S.C.	kW
1285	80	62	46.31	40.20	2.47	44.63	39.43	2.79	42.64	38.37	3.12	40.56	37.20	3.47	38.64	36.14	3.87	36.95	33.53	4.24
	80	67	50.56	33.93	2.45	49.24	33.39	2.78	47.38	32.70	3.13	45.03	31.85	3.50	42.25	30.82	3.91	39.08	29.58	4.32
	80	72	53.37	26.87	2.43	53.77	26.85	2.76	52.05	26.08	3.11	49.22	25.03	3.50	46.27	24.14	3.94	42.88	22.54	4.38
	75	62	47.00	32.98	2.53	45.15	32.25	2.91	43.28	31.48	3.26	41.39	30.67	3.59	39.49	29.82	3.92	36.97	28.03	4.19
1480	80	62	47.39	43.02	2.62	45.68	42.27	2.94	43.62	41.03	3.28	41.50	39.59	3.64	39.61	38.22	4.04	38.07	35.87	4.44
	80	67	51.15	35.69	2.60	50.09	35.40	2.92	48.22	34.79	3.27	45.76	33.95	3.64	42.95	33.00	4.08	40.01	31.00	4.50
	80	72	53.75	28.03	2.59	54.61	28.40	2.92	52.93	27.70	3.27	49.95	26.53	3.65	46.89	25.49	4.10	44.90	24.29	4.54
	75	62	48.24	35.14	2.63	46.51	34.50	2.99	44.62	33.72	3.34	42.59	32.80	3.69	40.41	31.72	4.07	37.35	28.68	4.41
1610	80	62	48.12	44.96	2.71	46.39	44.22	3.04	44.29	42.87	3.38	42.14	41.23	3.74	40.27	39.65	4.16	38.82	37.46	4.57
	80	67	51.81	37.01	2.70	51.16	37.07	3.02	49.16	36.47	3.37	46.39	35.51	3.74	43.38	34.53	4.18	40.71	33.30	4.62
	80	72	53.99	28.81	2.69	55.16	29.46	3.02	53.51	28.80	3.37	50.43	27.55	3.76	47.29	26.40	4.20	45.06	24.84	4.64
	75	62	49.02	36.59	2.70	47.37	36.01	3.03	45.55	35.27	3.39	43.48	34.32	3.75	41.10	33.07	4.17	37.61	29.12	4.56

## Boost Speed (C5) Cooling

### FSA1BG4MVRN48K with FG7 (Variable Speed) and C7BHM48C-C Coil

Outdoor Temperature:			65°F			75°F			85°F			95°F			105°F			115°F		
Blower cfm	Indoor EDB	Indoor EWB	T.C.	S.C.	kW	T.C.	S.C.	kW	T.C.	S.C.	kW	T.C.	S.C.	kW	T.C.	S.C.	kW	T.C.	S.C.	kW
1285	80	62	52.48	43.22	3.19	50.85	42.48	3.57	49.04	41.67	3.94	46.59	40.37	4.31	43.07	38.15	4.67	36.95	33.53	4.59
	80	67	56.50	36.81	3.22	56.22	36.46	3.59	54.17	35.54	3.94	50.62	34.11	4.25	45.83	32.18	4.54	40.42	29.95	4.54
	80	72	59.59	29.53	3.18	60.84	29.58	3.55	58.58	28.38	3.93	55.23	27.09	4.31	53.22	26.84	4.71	42.88	22.54	4.73
	75	62	54.20	36.54	3.20	52.45	35.60	3.58	50.13	34.56	3.95	47.53	33.57	4.32	44.96	32.78	4.69	36.97	28.03	4.53
1480	80	62	53.62	45.89	3.35	52.22	45.53	3.73	50.26	44.66	4.11	47.67	43.18	4.49	44.37	40.98	4.86	38.07	35.87	4.78
	80	67	56.97	38.31	3.38	57.36	38.80	3.81	55.89	38.38	4.18	52.13	36.65	4.51	46.50	33.74	4.78	41.10	31.00	4.68
	80	72	59.61	30.38	3.34	61.25	30.90	3.72	59.33	29.97	4.10	56.22	28.75	4.48	54.28	28.41	4.87	44.90	24.29	4.89
	75	62	55.32	38.46	3.36	53.95	37.88	3.74	51.50	36.72	4.12	48.76	35.47	4.49	46.47	34.66	4.87	37.35	28.68	4.70
1610	80	62	54.38	47.72	3.45	53.12	47.62	3.84	51.07	46.71	4.23	48.38	45.10	4.61	45.23	42.92	4.98	38.82	37.46	4.90
	80	67	57.82	39.62	3.47	58.31	40.38	3.87	56.27	39.82	4.22	52.33	38.25	4.53	47.16	35.95	4.80	41.54	33.30	4.79
	80	72	59.62	30.94	3.45	61.47	31.76	3.83	59.76	31.01	4.21	56.79	29.83	4.59	54.88	29.42	4.98	45.06	24.84	5.00
	75	62	56.07	39.77	3.47	54.93	39.44	3.85	52.41	38.19	4.23	49.57	36.76	4.61	47.47	35.93	4.98	37.61	29.12	4.82

# COOLING EXPANDED RATINGS WITH COIL AND VARIABLE SPEED FURNACE (CONT.)

## First Stage Low Speed (C1) Cooling

### FSA1BG4MVRN48K with FG7 (Variable Speed) and C7BHM48C-D Coil

Outdoor Temperature:			65°F			75°F			85°F			95°F			105°F			115°F		
Blower cfm	Indoor EDB	Indoor EWB	T.C.	S.C.	kW	T.C.	S.C.	kW	T.C.	S.C.	kW	T.C.	S.C.	kW	T.C.	S.C.	kW	T.C.	S.C.	kW
940	80	62	24.37	24.04	0.73	23.36	23.03	0.90	22.44	22.12	1.08	21.46	21.17	1.25	20.28	20.05	1.57	18.70	18.54	1.73
	80	67	26.29	20.65	0.70	24.93	20.05	0.88	23.55	19.48	1.05	22.15	18.91	1.23	20.77	18.38	1.56	19.37	17.82	1.74
	80	72	28.62	15.86	0.66	27.45	15.43	0.84	26.15	15.00	1.03	24.72	14.57	1.21	23.22	14.15	1.55	21.60	13.67	1.74
	75	62	24.29	19.83	0.74	23.10	19.35	0.91	21.85	18.78	1.08	20.56	18.16	1.26	19.32	17.53	1.58	18.10	16.89	1.75
990	80	62	24.74	24.39	0.73	23.69	23.36	0.90	22.76	22.44	1.07	21.75	21.48	1.25	20.55	20.33	1.57	18.92	18.78	1.73
	80	67	26.41	21.22	0.70	25.07	20.60	0.88	23.69	20.03	1.06	22.28	19.47	1.23	20.89	18.96	1.56	19.46	18.41	1.74
	80	72	28.73	16.22	0.66	27.57	15.80	0.84	26.28	15.38	1.03	24.84	14.96	1.21	23.32	14.52	1.55	21.66	14.03	1.74
	75	62	24.42	20.37	0.74	23.21	19.88	0.91	21.98	19.33	1.08	20.71	18.73	1.26	19.45	18.08	1.58	18.11	17.32	1.76
1070	80	62	25.33	24.95	0.72	24.23	23.89	0.90	23.26	22.96	1.07	22.21	21.97	1.25	20.96	20.78	1.57	19.26	19.15	1.73
	80	67	26.72	22.31	0.71	25.20	21.75	0.88	23.72	21.16	1.06	22.29	20.53	1.23	20.95	19.93	1.56	19.67	19.31	1.74
	80	72	28.92	16.79	0.66	27.77	16.40	0.84	26.48	16.00	1.03	25.02	15.57	1.21	23.47	15.13	1.55	21.77	14.60	1.75
	75	62	24.63	21.25	0.74	23.39	20.73	0.91	22.20	20.22	1.08	20.96	19.65	1.26	19.65	18.96	1.58	18.12	18.00	1.77

## Second Stage Rating Speed (C4) Cooling

### FSA1BG4MVRN48K with FG7 (Variable Speed) and C7BHM48C-D Coil

Outdoor Temperature:			65°F			75°F			85°F			95°F			105°F			115°F		
Blower cfm	Indoor EDB	Indoor EWB	T.C.	S.C.	kW	T.C.	S.C.	kW	T.C.	S.C.	kW	T.C.	S.C.	kW	T.C.	S.C.	kW	T.C.	S.C.	kW
1400	80	62	47.64	42.47	2.44	45.90	41.69	2.76	43.83	40.50	3.10	41.69	39.14	3.45	39.74	37.87	3.86	38.11	36.81	4.24
	80	67	51.60	35.44	2.42	50.39	35.02	2.75	48.49	34.36	3.10	46.03	33.50	3.47	43.20	32.50	3.89	40.13	31.41	4.31
	80	72	54.28	27.91	2.41	54.91	28.09	2.74	53.18	27.35	3.09	50.22	26.21	3.47	47.17	25.22	3.92	44.57	24.63	4.36
	75	62	48.42	34.74	2.48	46.60	34.04	2.84	44.69	33.25	3.19	42.68	32.35	3.53	40.57	31.35	3.89	37.69	29.69	4.21
1480	80	62	48.08	43.65	2.48	46.33	42.87	2.80	44.23	41.61	3.14	42.07	40.13	3.49	40.14	38.73	3.90	38.57	37.56	4.30
	80	67	51.84	36.17	2.46	50.74	35.86	2.78	48.83	35.23	3.13	<b>46.33</b>	<b>34.38</b>	<b>3.50</b>	43.48	33.41	3.93	40.51	32.44	4.36
	80	72	54.44	28.39	2.45	55.26	28.74	2.77	53.54	28.02	3.13	50.52	26.84	3.51	47.42	25.78	3.96	45.40	25.46	4.40
	75	62	48.92	35.64	2.49	47.16	34.98	2.84	45.24	34.18	3.20	43.17	33.24	3.55	40.95	32.14	3.93	37.84	30.29	4.27
1600	80	62	48.76	45.45	2.53	46.99	44.69	2.85	44.85	43.32	3.19	42.66	41.66	3.56	40.76	40.06	3.98	39.26	38.68	4.38
	80	67	52.45	37.39	2.52	51.73	37.41	2.84	49.70	36.79	3.18	46.91	35.83	3.56	43.88	34.84	4.00	41.15	34.19	4.43
	80	72	54.66	29.12	2.51	55.77	29.72	2.83	54.08	29.05	3.19	50.97	27.78	3.57	47.80	26.63	4.02	45.55	26.09	4.46
	75	62	49.65	36.99	2.52	47.95	36.38	2.85	46.09	35.63	3.21	43.99	34.65	3.57	41.58	33.40	3.98	38.08	31.20	4.37

## Boost Speed (C5) Cooling

### FSA1BG4MVRN48K with FG7 (Variable Speed) and C7BHM48C-D Coil

Outdoor Temperature:			65°F			75°F			85°F			95°F			105°F			115°F		
Blower cfm	Indoor EDB	Indoor EWB	T.C.	S.C.	kW	T.C.	S.C.	kW	T.C.	S.C.	kW	T.C.	S.C.	kW	T.C.	S.C.	kW	T.C.	S.C.	kW
1400	80	62	53.84	45.37	3.17	52.31	44.83	3.55	50.37	43.96	3.93	47.80	42.53	4.30	44.37	40.29	4.67	38.11	35.36	4.59
	80	67	57.46	38.15	3.20	57.55	38.27	3.60	55.80	37.61	3.97	52.09	35.99	4.29	46.76	33.48	4.56	41.32	30.94	4.50
	80	72	60.29	30.38	3.16	61.73	30.68	3.53	59.63	29.62	3.91	56.39	28.36	4.30	54.38	28.04	4.69	44.57	23.83	4.71
	75	62	55.55	38.14	3.18	53.98	37.39	3.56	51.55	36.26	3.93	48.82	35.09	4.31	46.39	34.28	4.68	37.69	28.79	4.52
1480	80	62	54.31	46.48	3.21	52.87	46.10	3.59	50.87	45.21	3.97	48.24	43.70	4.35	44.90	41.48	4.72	38.57	36.34	4.63
	80	67	57.66	38.77	3.24	58.01	39.24	3.67	56.51	38.80	4.04	52.71	37.05	4.37	47.04	34.13	4.64	41.60	31.38	4.53
	80	72	60.30	30.73	3.20	61.90	31.23	3.58	59.94	30.28	3.96	56.80	29.05	4.34	54.82	28.69	4.73	45.40	24.56	4.75
	75	62	56.01	38.94	3.22	54.60	38.34	3.60	52.11	37.16	3.97	49.33	35.89	4.35	47.00	35.06	4.73	37.84	29.06	4.56
1600	80	62	55.01	48.18	3.27	53.70	48.04	3.66	51.62	47.11	4.04	48.90	45.48	4.42	45.70	43.28	4.80	39.26	37.82	4.71
	80	67	58.44	39.99	3.29	58.89	40.71	3.69	56.85	40.14	4.04	52.89	38.55	4.35	47.65	36.18	4.62	42.00	33.52	4.60
	80	72	60.31	31.25	3.26	62.10	32.03	3.64	60.33	31.24	4.03	57.32	30.05	4.41	55.37	29.63	4.79	45.55	25.07	4.82
	75	62	56.70	40.16	3.28	55.51	39.78	3.66	52.95	38.52	4.04	50.08	37.09	4.42	47.92	36.23	4.80	38.08	29.47	4.63

# COOLING EXPANDED RATINGS WITH COIL AND VARIABLE SPEED FURNACE (CONT.)

## First Stage Low Speed (C1) Cooling

FSA1BG4MVRN60K with FG7 (Variable Speed) and C7BHMx60C-C Coil

Outdoor Temperature:			65°F			75°F			85°F			95°F			105°F			115°F		
Blower cfm	Indoor EDB	Indoor EWB	T.C.	S.C.	kW	T.C.	S.C.	kW	T.C.	S.C.	kW	T.C.	S.C.	kW	T.C.	S.C.	kW	T.C.	S.C.	kW
990	80	62	23.04	22.45	0.65	21.98	21.52	0.80	20.97	20.54	0.97	20.00	19.51	1.13	19.09	18.46	1.49	18.22	17.39	1.67
	80	67	23.80	20.25	0.64	22.70	19.67	0.80	21.56	19.14	0.97	20.38	18.65	1.14	19.16	18.18	1.49	17.91	17.70	1.66
	80	72	25.97	15.30	0.58	24.82	14.90	0.75	23.57	14.56	0.92	22.22	14.24	1.09	20.76	13.93	1.46	19.19	13.58	1.65
	75	62	22.05	19.49	0.67	21.01	19.13	0.84	19.98	18.60	1.00	18.97	17.95	1.16	17.97	17.17	1.50	16.99	16.30	1.66
1080	80	62	23.51	22.93	0.67	22.44	21.96	0.83	21.40	20.94	0.99	20.41	19.88	1.16	19.47	18.79	1.52	18.56	17.67	1.70
	80	67	24.10	21.25	0.67	22.95	20.72	0.83	21.79	20.11	1.00	20.64	19.42	1.17	19.48	18.67	1.52	18.33	17.85	1.69
	80	72	26.07	15.93	0.61	24.98	15.55	0.78	23.75	15.23	0.95	22.40	14.93	1.13	20.93	14.62	1.49	19.33	14.26	1.68
	75	62	22.25	20.42	0.70	21.13	20.09	0.86	20.09	19.48	1.02	19.12	18.63	1.19	18.23	17.59	1.53	17.42	16.40	1.69
1210	80	62	24.19	23.63	0.70	23.09	22.61	0.87	22.03	21.53	1.03	21.01	20.41	1.21	20.01	19.26	1.56	19.06	18.08	1.73
	80	67	24.54	22.72	0.71	23.30	22.26	0.88	22.12	21.53	1.05	21.00	20.55	1.22	19.94	19.38	1.56	18.95	18.05	1.73
	80	72	26.23	16.84	0.66	25.19	16.50	0.82	24.01	16.21	0.99	22.67	15.93	1.17	21.18	15.63	1.53	19.54	15.25	1.73
	75	62	22.54	21.59	0.74	21.31	21.05	0.90	20.24	20.24	1.06	19.34	19.22	1.22	18.61	18.04	1.57	18.04	16.73	1.74

## Second Stage Rating Speed (C4) Cooling

FSA1BG4MVRN60K with FG7 (Variable Speed) and C7BHMx60C-C Coil

Outdoor Temperature:			65°F			75°F			85°F			95°F			105°F			115°F		
Blower cfm	Indoor EDB	Indoor EWB	T.C.	S.C.	kW	T.C.	S.C.	kW	T.C.	S.C.	kW	T.C.	S.C.	kW	T.C.	S.C.	kW	T.C.	S.C.	kW
1480	80	62	55.42	47.09	3.14	53.38	45.98	3.51	51.07	44.77	3.92	48.50	43.41	4.36	45.65	41.86	4.82	42.55	40.07	5.33
	80	67	60.29	39.63	3.17	58.36	38.94	3.55	55.96	38.01	3.96	53.15	36.85	4.40	49.98	35.46	4.88	46.50	33.84	5.38
	80	72	63.94	31.93	3.13	63.66	31.74	3.52	61.36	30.73	3.95	57.99	29.35	4.43	54.49	28.04	4.95	51.80	27.25	5.51
	75	62	56.04	38.96	3.14	54.01	38.02	3.51	51.72	36.96	3.92	49.17	35.75	4.36	46.35	34.38	4.83	43.27	32.80	5.35
1610	80	62	56.38	49.00	3.22	54.28	47.95	3.59	51.90	46.72	4.01	49.24	45.27	4.46	46.31	43.59	4.94	43.11	41.61	5.47
	80	67	60.89	41.08	3.24	59.03	40.47	3.63	56.55	39.53	4.04	<b>53.60</b>	<b>38.34</b>	<b>4.49</b>	50.36	36.97	4.96	47.00	35.50	5.47
	80	72	64.39	32.68	3.21	64.35	32.64	3.60	62.09	31.68	4.03	58.64	30.28	4.51	55.03	28.94	5.03	52.30	28.16	5.59
	75	62	56.96	40.32	3.22	54.84	39.37	3.60	52.45	38.30	4.00	49.79	37.09	4.45	46.86	35.71	4.92	43.66	34.12	5.44
1805	80	62	57.82	51.93	3.34	55.63	50.96	3.71	53.14	49.71	4.14	50.37	48.14	4.61	47.30	46.24	5.12	43.95	43.95	5.69
	80	67	61.79	43.29	3.36	60.05	42.81	3.75	57.43	41.85	4.16	54.28	40.61	4.61	50.94	39.27	5.09	47.74	38.05	5.60
	80	72	65.06	33.83	3.33	65.39	34.02	3.71	63.19	33.13	4.15	59.62	31.70	4.63	55.85	30.31	5.15	53.05	29.55	5.72
	75	62	58.36	42.40	3.35	56.10	41.44	3.72	53.55	40.37	4.14	50.73	39.15	4.58	47.62	37.75	5.06	44.23	36.13	5.58

## Boost Speed (C5) Cooling

FSA1BG4MVRN60K with FG7 (Variable Speed) and C7BHMx60C-C Coil

Outdoor Temperature:			65°F			75°F			85°F			95°F			105°F			115°F		
Blower cfm	Indoor EDB	Indoor EWB	T.C.	S.C.	kW	T.C.	S.C.	kW	T.C.	S.C.	kW	T.C.	S.C.	kW	T.C.	S.C.	kW	T.C.	S.C.	kW
1480	80	62	63.96	51.36	4.27	61.56	50.02	4.71	58.90	48.69	5.20	56.00	47.35	5.72	52.88	45.95	6.28	49.56	44.45	6.88
	80	67	69.11	43.52	4.33	67.40	42.78	4.82	64.74	41.61	5.32	61.41	40.15	5.83	57.71	38.53	6.36	53.92	36.92	6.90
	80	72	71.70	36.86	4.33	71.77	36.27	4.84	69.91	34.94	5.37	66.75	33.18	5.91	62.90	31.28	6.46	58.98	29.52	7.02
	75	62	64.81	43.11	4.29	62.59	42.10	4.73	59.84	40.80	5.21	56.81	39.36	5.73	53.74	37.92	6.29	50.88	36.64	6.88
1610	80	62	65.22	53.49	4.36	62.81	52.21	4.81	60.00	50.75	5.30	56.93	49.18	5.83	53.77	47.60	6.39	50.66	46.10	7.00
	80	67	69.93	44.90	4.43	68.56	44.38	4.93	65.88	43.21	5.44	62.37	41.64	5.95	58.49	39.92	6.47	54.71	38.34	7.00
	80	72	72.32	37.26	4.41	72.87	37.05	4.94	71.15	35.92	5.47	67.85	34.21	6.00	63.65	32.26	6.53	59.22	30.36	7.06
	75	62	65.99	44.55	4.37	63.86	43.66	4.81	60.96	42.24	5.30	57.72	40.58	5.83	54.60	38.98	6.41	52.03	37.76	7.03
1805	80	62	67.11	56.77	4.49	64.69	55.59	4.95	61.64	53.91	5.45	58.33	51.99	5.99	55.10	50.13	6.57	52.30	48.63	7.18
	80	67	71.05	47.03	4.53	70.13	46.89	5.02	67.51	45.76	5.54	63.81	44.03	6.07	59.68	42.08	6.63	55.76	40.31	7.22
	80	72	73.25	37.86	4.52	74.52	38.22	5.08	73.02	37.41	5.62	69.51	35.80	6.14	64.77	33.76	6.64	59.60	31.63	7.12
	75	62	67.29	46.21	4.51	65.25	45.18	4.97	62.63	44.08	5.46	59.34	42.79	5.97	55.74	41.48	6.51	53.17	41.09	7.07



# COOLING EXPANDED RATINGS WITH COIL AND VARIABLE SPEED FURNACE (CONT.)

## First Stage Low Speed (C1) Cooling

FSA1BG4MVRN60K with FG7 (Variable Speed) and C7BHM60C-D Coil

Outdoor Temperature:			65°F			75°F			85°F			95°F			105°F			115°F		
Blower cfm	Indoor EDB	Indoor EWB	T.C.	S.C.	kW	T.C.	S.C.	kW	T.C.	S.C.	kW	T.C.	S.C.	kW	T.C.	S.C.	kW	T.C.	S.C.	kW
990	80	62	23.14	22.55	0.63	22.09	21.62	0.78	21.08	20.65	0.95	20.13	19.63	1.12	19.22	18.58	1.47	18.36	17.52	1.65
	80	67	23.90	20.34	0.62	22.81	19.76	0.79	21.68	19.24	0.95	20.51	18.77	1.12	19.29	18.30	1.47	18.04	17.83	1.64
	80	72	26.07	15.36	0.56	24.93	14.96	0.73	23.69	14.63	0.90	22.34	14.32	1.08	20.89	14.02	1.44	19.33	13.67	1.63
	75	62	22.15	19.58	0.65	21.11	19.22	0.82	20.09	18.71	0.98	19.09	18.06	1.14	18.10	17.30	1.48	17.12	16.43	1.64
1070	80	62	23.51	22.92	0.99	22.44	21.97	1.15	21.42	20.96	1.32	20.44	19.91	1.49	19.50	18.82	1.84	18.61	17.72	2.02
	80	67	24.12	21.18	0.99	22.97	20.65	1.16	21.83	20.05	1.33	20.68	19.40	1.50	19.52	18.69	1.84	18.37	17.91	2.01
	80	72	26.11	15.89	0.94	25.01	15.51	1.10	23.79	15.19	1.27	22.45	14.90	1.45	20.99	14.60	1.82	19.40	14.24	2.01
	75	62	22.28	20.36	1.03	21.17	20.04	1.19	20.14	19.44	1.35	19.17	18.62	1.51	18.28	17.62	1.85	17.45	16.47	2.02
1205	80	62	24.21	23.65	1.10	23.12	22.64	1.27	22.07	21.57	1.44	21.05	20.46	1.61	20.07	19.31	1.96	19.12	18.15	2.13
	80	67	24.57	22.70	1.11	23.34	22.26	1.28	22.17	21.53	1.45	21.05	20.57	1.62	20.00	19.42	1.96	19.01	18.12	2.13
	80	72	26.27	16.84	1.06	25.24	16.50	1.22	24.06	16.21	1.39	22.73	15.94	1.57	21.25	15.65	1.94	19.62	15.28	2.13
	75	62	22.58	21.59	1.14	21.36	21.07	1.30	20.30	20.27	1.46	19.40	19.27	1.63	18.67	18.10	1.97	18.10	16.79	2.14

## Second Stage Rating Speed (C4) Cooling

FSA1BG4MVRN60K with FG7 (Variable Speed) and C7BHM60C-D Coil

Outdoor Temperature:			65°F			75°F			85°F			95°F			105°F			115°F		
Blower cfm	Indoor EDB	Indoor EWB	T.C.	S.C.	kW	T.C.	S.C.	kW	T.C.	S.C.	kW	T.C.	S.C.	kW	T.C.	S.C.	kW	T.C.	S.C.	kW
1480	80	62	56.07	47.64	2.98	53.98	46.50	3.35	51.63	45.26	3.76	49.01	43.87	4.20	46.12	42.29	4.66	42.97	40.48	5.16
	80	67	60.93	40.06	3.01	58.96	39.34	3.39	56.52	38.39	3.80	53.67	37.21	4.24	50.45	35.80	4.72	46.93	34.15	5.22
	80	72	64.59	32.25	2.97	64.26	32.04	3.36	61.92	31.01	3.79	58.50	29.61	4.27	54.96	28.28	4.79	52.23	27.47	5.35
	75	62	56.68	39.41	2.98	54.61	38.44	3.35	52.28	37.36	3.76	49.68	36.13	4.20	46.82	34.73	4.67	43.70	33.13	5.18
1600	80	62	56.96	49.41	3.05	54.81	48.32	3.43	52.39	47.07	3.84	49.70	45.60	4.29	46.73	43.89	4.77	43.49	41.90	5.30
	80	67	61.49	41.40	3.08	59.58	40.76	3.46	57.06	39.80	3.88	54.08	38.59	4.32	50.80	37.20	4.79	47.38	35.70	5.30
	80	72	65.00	32.95	3.04	64.90	32.88	3.43	62.59	31.89	3.86	59.11	30.47	4.34	55.46	29.11	4.86	52.68	28.32	5.43
	75	62	57.54	40.67	3.06	55.38	39.70	3.43	52.96	38.61	3.84	50.26	37.37	4.28	47.29	35.97	4.76	44.05	34.35	5.27
1800	80	62	58.43	52.43	3.18	56.19	51.43	3.55	53.67	50.15	3.97	50.85	48.56	4.44	47.75	46.63	4.96	44.35	44.31	5.52
	80	67	62.42	43.68	3.19	60.62	43.18	3.58	57.96	42.20	4.00	54.78	40.93	4.45	51.39	39.57	4.93	48.14	38.33	5.43
	80	72	65.69	34.13	3.16	65.97	34.30	3.55	63.72	33.38	3.98	60.11	31.94	4.46	56.30	30.53	4.98	53.45	29.76	5.55
	75	62	58.97	42.82	3.18	56.67	41.83	3.56	54.08	40.73	3.97	51.22	39.49	4.42	48.07	38.07	4.90	44.64	36.42	5.41

## Boost Speed (C5) Cooling

FSA1BG4MVRN60K with FG7 (Variable Speed) and C7BHM60C-D Coil

Outdoor Temperature:			65°F			75°F			85°F			95°F			105°F			115°F		
Blower cfm	Indoor EDB	Indoor EWB	T.C.	S.C.	kW	T.C.	S.C.	kW	T.C.	S.C.	kW	T.C.	S.C.	kW	T.C.	S.C.	kW	T.C.	S.C.	kW
1480	80	62	64.60	51.88	4.11	62.16	50.51	4.55	59.46	49.16	5.03	56.51	47.78	5.56	53.35	46.36	6.12	49.99	44.83	6.72
	80	67	69.76	43.93	4.17	68.00	43.16	4.66	65.30	41.97	5.16	61.93	40.48	5.67	58.18	38.85	6.20	54.34	37.21	6.74
	80	72	72.35	37.19	4.17	72.37	36.58	4.68	70.47	35.22	5.21	67.26	33.43	5.75	63.37	31.51	6.30	59.40	29.73	6.86
	75	62	65.46	43.54	4.13	63.19	42.50	4.57	60.40	41.18	5.05	57.32	39.71	5.57	54.21	38.25	6.13	51.31	36.95	6.72
1600	80	62	65.77	53.85	4.19	63.31	52.54	4.64	60.47	51.06	5.13	57.38	49.48	5.66	54.17	47.89	6.22	51.00	46.36	6.83
	80	67	70.51	45.20	4.26	69.07	44.65	4.76	66.35	43.45	5.27	62.81	41.87	5.78	58.90	40.14	6.30	55.08	38.53	6.83
	80	72	72.92	37.56	4.24	73.39	37.29	4.77	71.61	36.12	5.30	68.28	34.39	5.83	64.06	32.42	6.37	59.63	30.51	6.90
	75	62	66.55	44.88	4.21	64.36	43.95	4.65	61.43	42.51	5.13	58.17	40.85	5.66	55.00	39.24	6.24	52.36	37.98	6.86
1800	80	62	67.71	57.23	4.33	65.24	56.02	4.79	62.16	54.32	5.29	58.81	52.38	5.83	55.54	50.49	6.40	52.69	48.96	7.02
	80	67	71.66	47.41	4.36	70.69	47.22	4.86	68.02	46.07	5.37	64.29	44.32	5.91	60.12	42.35	6.47	56.16	40.56	7.05
	80	72	73.88	38.18	4.36	75.08	38.50	4.92	73.53	37.65	5.45	69.98	36.03	5.97	65.21	33.97	6.48	60.01	31.82	6.96
	75	62	67.90	46.61	4.35	65.82	45.55	4.81	63.15	44.43	5.30	59.82	43.10	5.81	56.18	41.76	6.34	53.56	41.34	6.90







### GENERAL TERMS OF LIMITED WARRANTY

Nortek Global HVAC, LLC will furnish a replacement for any part of this product which fails in normal use and service within the terms and conditions of the warranty.

For complete details of the Limited Warranty, including applicable terms and conditions, see your local installer or contact the Nortek Global HVAC, LLC warranty department for a copy.

Before purchasing this appliance, read important energy cost and efficiency information available from your retailer. Specifications and illustrations subject to change without notice and without incurring obligations. Printed in U.S.A (04/2017)